



WALKER

Products, Inc. *The Custom Board People*



Page 29



Page 10

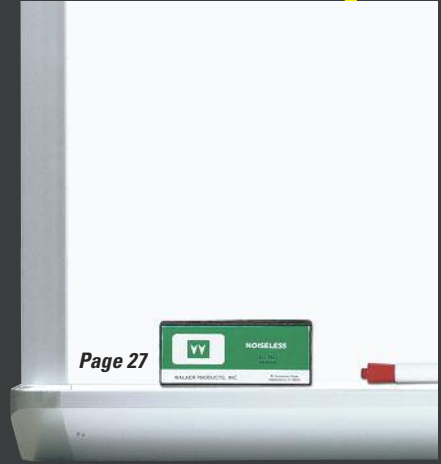

Page 27



Page 16



Page 9

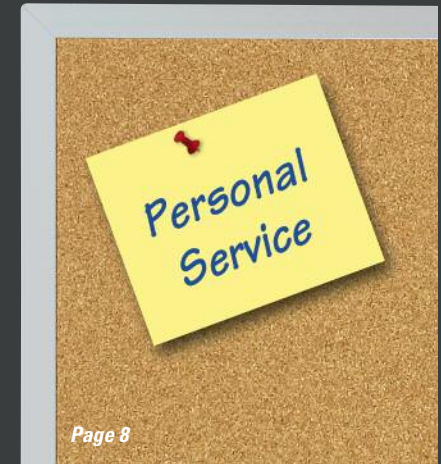

Page 8



Page 20

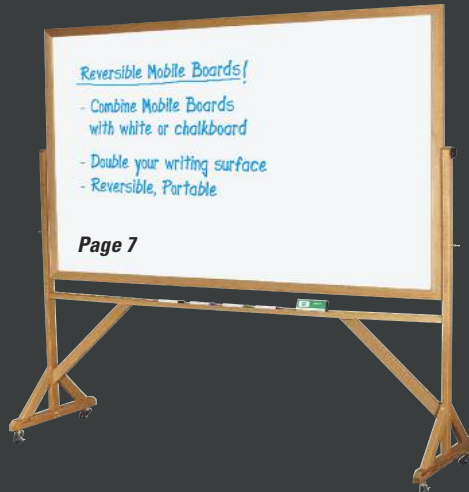

Reversible Mobile Boards!

- Combine Mobile Boards with white or chalkboard
- Double your writing surface
- Reversible, Portable

Page 7



Page 18



WALKER PRODUCTS, INC.

80 Commerce Street
Glastonbury, CT 06033

Quality Custom & Stock Communication Boards *Made in USA Since 1964*
JANUARY 2015

PRODUCT LOCATOR

Reference
Page 2



Wood Finish Selections

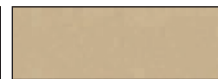

FORBO® Color Selections



Vinyl Color Selections

Walker Difference - Page 3

Walker Advantage Line



Page 4

Walker Show-Off Line



Page 5



Page 6



Page 7

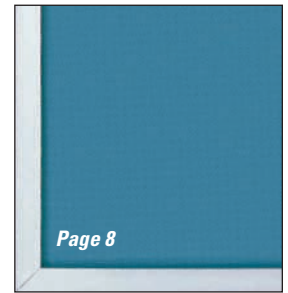

Page 8

Walker Headliner Series



Page 9

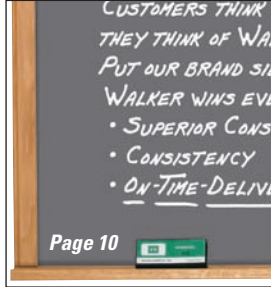

Page 10



Page 11

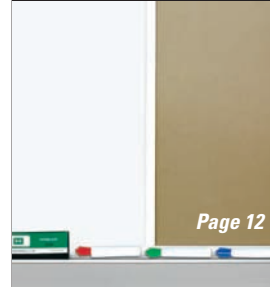

Page 12

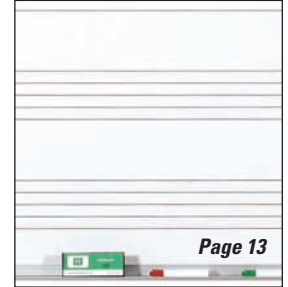

Page 13



Page 14



Page 15



Page 16



Page 17



Page 18

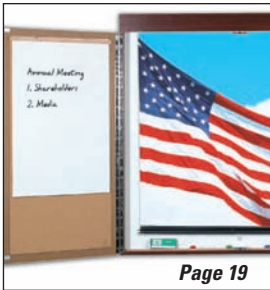

Page 19

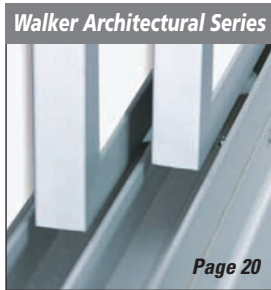

Walker Architectural Series

Page 20



Page 21

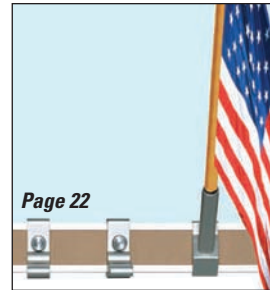

Page 22

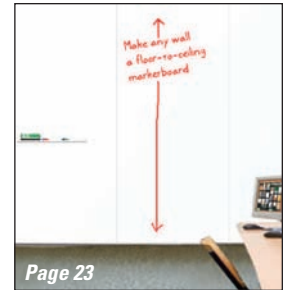

Page 23

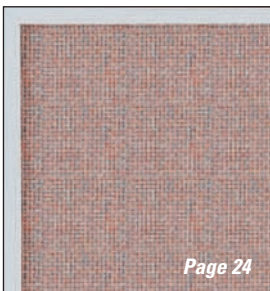

Page 24

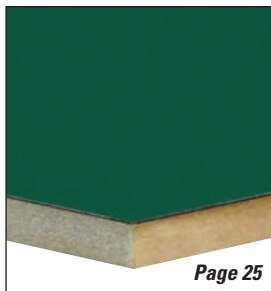

Page 25

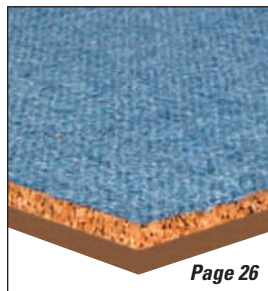

Page 26



Page 27



Page 28



Page 29

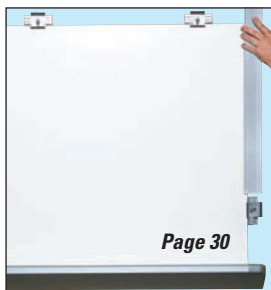

Page 30



Page 31

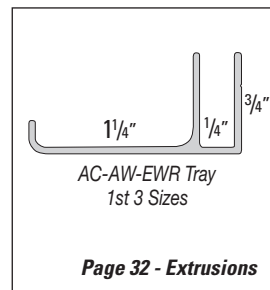

AC-AW-EWR Tray
1st 3 Sizes

Page 32 - Extrusions



Page 34 - Fabric Coverings



Walker Products Inc.

800 828.2096

www.walkerboard.com

A

WALKER OPTIONS

“4 Quality Lines”

Meet Your Client's Needs with 4 Lines of Quality Walker Products

You can have it all at Walker Products. Choose from four lines of communication boards to match your project's special needs for:

- Price
- Frame Finish & Thickness
- Writing Board Material & Colors
- Fabric, Vinyl, Natural and FORBO® Cork Tackboards
- Trays, Maprails
- Sizes
- Class A Fire-Rated Tackboards
- Special Customization

Advantage is Walker's budget-priced markerboards and tackboards in 3 popular sizes.

Show Off is Walker's tough mid-priced workhorse chalk, marker and bulletin boards with superior construction.

Headliner is Walker's premium communication boards featuring heavy duty frames, deeper trays, maprails, hanging hardware and more frame and board options.

Architectural Series offers top-of-the-line boards for architecturally spec'd products – dozens of customized configurations, FORBO® tackboards, backing, fire-rated stock and custom materials are available.



INDEX

Reference: Wood, FORBO®, Burlap-Textured Vinyl Wrap	2
The Walker Difference	3
Advantage Line.....	4
Show-Off Marker & Combo Boards	5
Show-Off Chalk Talkers & Combo Boards.....	6
Show-Off Reversible Boards.....	7
Show-Off Bulletin Boards	8
Headliner Porcelain White-Rite Boards	9
Headliner Porcelain Enamel Chalk & Combo Boards.....	10
Headliner Reversible Boards	11
Headliner Bulletin & Combo White-Rite Boards.....	12
Headliner White-Rite Grid Boards	13
Headliner Frameless Porcelain Boards	14
Headliner Radii Fabric-Covered Communication Boards.....	15
Headliner Radii White-Rite & Chalkboards.....	16
Headliner Enclosed Bulletin & Directory Boards.....	17
Headliner Sliding Glass Bulletin Boards	18
Headliner Astro Conference Center & Open Face Directories	19
Architectural Series Horizontal Sliding Markerboards.....	20
Architectural Series Floor to Ceiling Horizontal Sliding Units	21
Map, Display Rails & Accessories	22
Headliner Floor-to-Ceiling White Markerboards	23
Headliner Guilford Fabric Tackboards	24
Porcelain Writing Surfaces	25
Architectural Series Tackboard Selector.....	26
Deluxe Architectural Series Trim.....	27
Standard Architectural Series Trim	28
Wood Architectural Series	29
Snap-On Architectural Series.....	30
Architectural Series Tack Walls.....	31
The Walker Difference	32
Aluminum Extrusions.....	33
Reference: Fabric Coverings	34



Standard Architectural trim with box tray and cast endcaps



Gloss poly red oak Architectural trim and tray



Standard trim with 2" maprail

NOTE: Pricing and specifications may change without notice; contact Walker Products to confirm pricing, availability and specifications. Many of our products are custom-made and are not returnable.

© 2007 Walker Products Inc.



Walker Products Inc.

800 828.2096 www.walkerboard.com

Special Pullout Color Reference

Front Cover: Wood, FORBO®, Vinyl Selections

Back Cover: Fabric Selections

1

WBT Chalkboard Porcelain: jet black 6501U

Wood Finish Selections

REFERENCE

Walker wood frames are exactly that — solid wood frames. Some customers have told us that when they ordered from other companies in the past, they received imitation vinyl wood-grains instead of the solid wood they were expecting.

STANDARD	CUSTOM STAINS		ARCHITECTURAL SERIES		
					
White Oak, Oil Finish	Cherry Stain on White Oak, Satin Finish	Dark Red Mahogany Stain on White Oak, Satin Finish	Satin Maple	Gloss Maple	Red Oak, Gloss Poly Finish

FORBO® Cork Linoleum Color Selections

FORBO® cork linoleum is the most durable tackable surface available. 1/4" thick, it is washable, stain and fade resistant, self-healing, and resists cracking, drying and peeling. Available in 12 popular colors. All colors available in 4' heights. Six colors available in 6' heights*.

			
2186*	2187	2162*	2201
			
2067*	2182*	2185*	2202
			
2166*	2203	2204	2205

Burlap-Textured Vinyl Bulletin Board Selections

Walker vinyl is Class A fire rated, washable, colorfast, and stain and fade resistant. Weight is 18 oz. per linear yard. Available in vibrant colors, our vinyl is up to 30 - 40% heavier than many of our competitors'.

			
Atrium	Crystal Beach	Winter Mist	Cotton
			
Sea Mist	Silver Fox	Antique White	Sand Harbor
			
Natural	Surf	Bayberry	Breakwater
			
Seneca Lake	Monterey Jack	Hollywood Red	Wineberry
			
Pacific	Blue Saga	Tahoe	Indigo

NOTE: If color is critical, call for a color swatch.

FORBO is a registered trademark of Forbo Linoleum Inc.



THE WALKER EDGE

“They’re the Best”



The Walker Difference

In the middle of the summer we got a call from a contractor. They needed 272, 8' markerboards and 272, 8' tackboards in 10 days. We got it done right and delivered on time.

We keep a lot of materials in stock so we can respond quickly to your needs and offer more flexibility in our product offerings.

We have been making boards since 1964. Walker has the experience, the track record and the right equipment for precision, efficiency and quality. We're committed and invest in the right tools and inventory.

For a modular classroom order that had to be shipped in 3 days – we did it in 2!

Customers come to Walker because our competition can't compete with our:

- Delivery speed
- Quality
- Customization options
- Personal service

When you call with questions you will speak directly with our General Manager. You'll get answers and you'll know what we can and can't do.

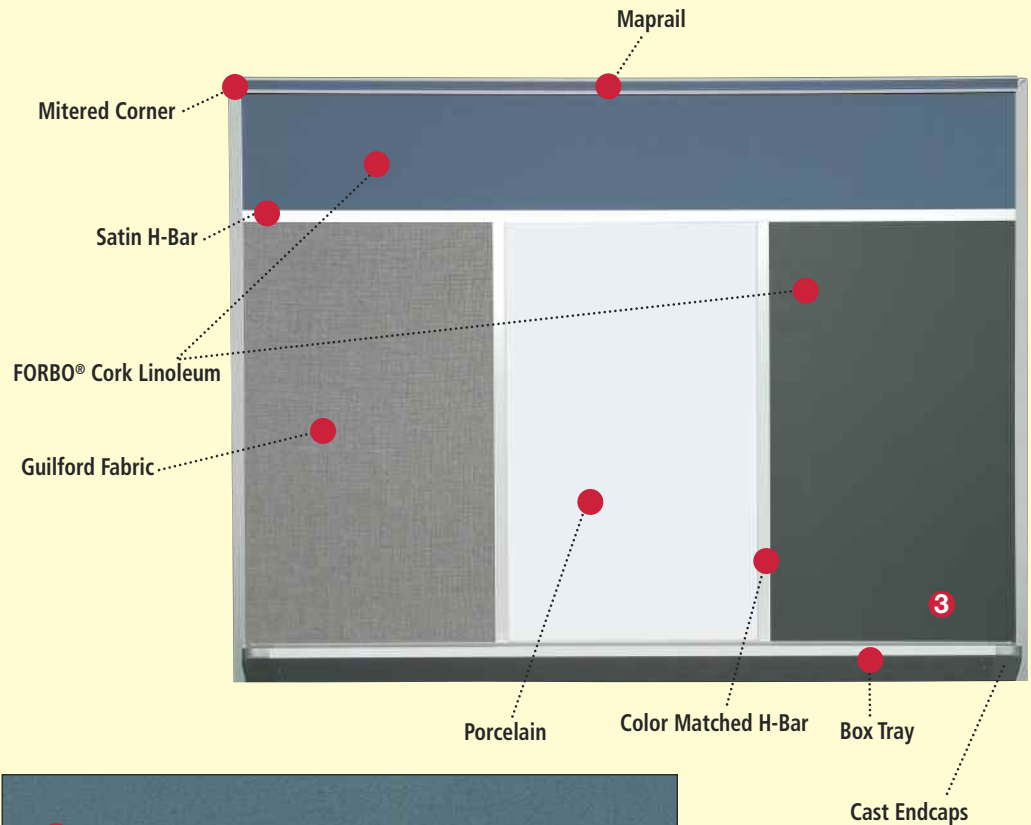

Attention to detail, quality materials and stellar workmanship is the foundation of Walker's full-line of communication boards.

- 1) Top FORBO® tackboard is #2185
- 2) Fabric tackboard is Quartz
- 3) FORBO® on the right side of the board above is #2204
- 4) Satin H-Bar
- 5) White Color Matched H-Bar



Walker Products Inc.

800 828.2096

www.walkerboard.com

3



Aluminum Frame Markerboards

- Clear anodized trim for clean long-lasting appearance
- Premium quality melamine surface erases cleanly again and again
- Full length marker tray for easy storage of markers and eraser
- Hangers included and attached

Aluminum Frame Porcelain Markerboards

- Porcelain enamel on steel will last a lifetime
- Holds magnets
- Will not fade, stain or wear out
- Clear anodized trim and tray
- Hangers included and attached

Wood Frame Bulletin Boards

- Oil finished white oak trim resists staining
- Corners mitered and stapled for tight, flush joints
- Hangers included and attached

Aluminum Frame Bulletin Boards

- Clear anodized trim for clean long-lasting appearance
- Fine grained natural cork laminated to rigid fiberboard
- Hangers included and attached

"Walker craftsmen stay with the job from start to finish - we don't run an assembly line.

Our people take pride in the Walker name and the products they make."

EWR

Aluminum frame with porcelain markerboard (left)

White oak oil finish trim bulletin board with fine grained natural cork - a great look and a great value (lower left)

Aluminum frame bulletin board with all natural cork offers a clean, long-lasting appearance (lower right)

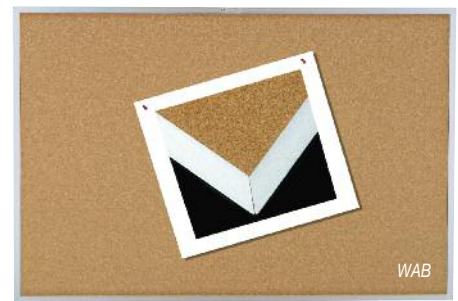

H x W (in.)	Markerboards Alum. Frame		Porcelain Markerboards Alum. Frame		Bulletin Boards Oak Frame		Bulletin Boards Alum. Frame	
	Alum. Frame	List	Alum. Frame	List	Oak Frame	List	Alum. Frame	List
18 x 24	WAW1824	33.00	EWR1824	68.25	WOB1824	34.00	WAB1824	32.00
24 x 36	WAW2436	47.00	EWR2436	109.00	WOB2436	46.00	WAB2436	44.00
36 x 48	WAW3648	71.00	EWR3648	190.00	WOB3648	69.00	WAB3648	67.00



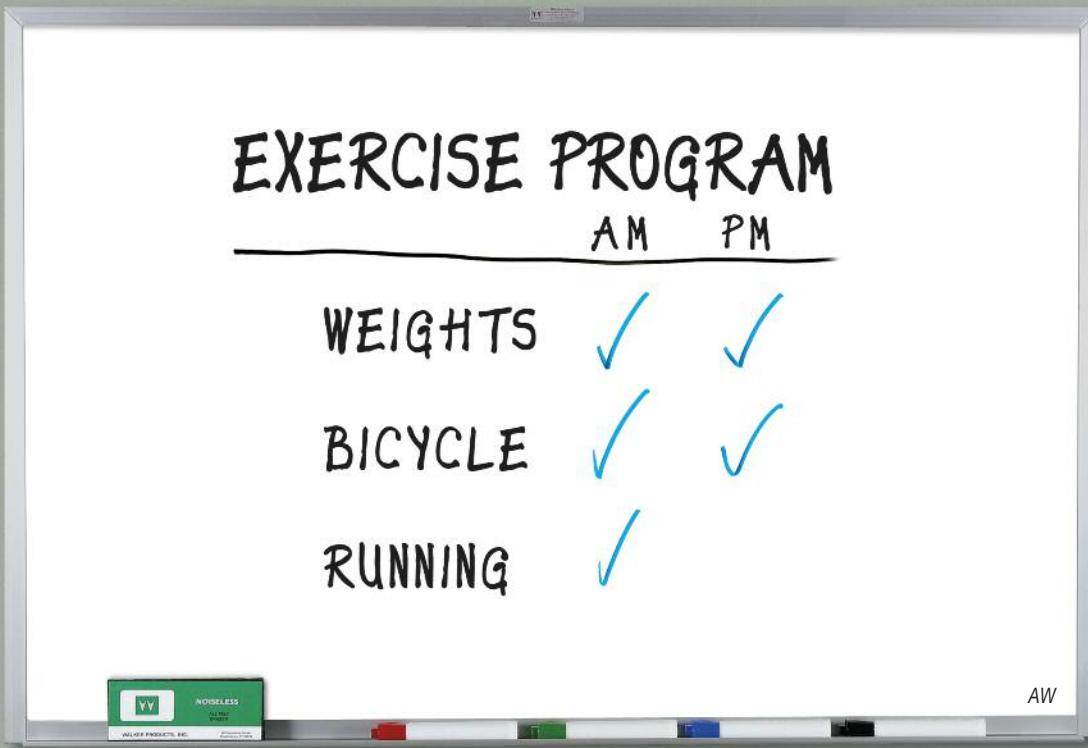

Show-Off White Markerboards

- Mid-priced Show-Off Boards ideal for multiple installations
- Available with satin anodized-aluminum or oil finish white oak trim
- 1/4" thick melamine markerboard
- Folding attached hangers
- Marker easily wipes clean with dry eraser
- Superior construction for lasting durability
- All boards come complete with 4 markers, 1 eraser and full marker tray
- Standard wood finish see page 2



Show-Off Combo Boards

- Versatile combination of markerboard and natural cork bulletin board

Options:

- Custom Stain – add \$70.00 or 20%, whichever is greater, see page 2 for custom wood stains
- Custom Sizes – boards may be ordered in custom sizes or with minor alterations; take the price of the next largest size and add \$70.00 or 20%, whichever is greater



Folding attached hangers are standard

H x W (in.)	White Markerboards Alum. Frame		White Markerboards Oak Frame		White Comb. Board Alum. Frame		White Comb. Board Oak Frame	
	AW	List	OW	List	AWC	List	OWC	List
18 x 24	AW1824	48.65	OW1824	49.95	—	—	—	—
24 x 36	AW2436	66.20	OW2436	69.95	AWC2436	90.00	OWC2436	94.00
36 x 48	AW3648	92.00	OW3648	93.00	AWC3648	115.00	OWC3648	126.00
36 x 60	AW3660	176.00	OW3660	193.00	AWC3660	205.00	OWC3660	225.00
48 x 48	AW4848	165.00	OW4848	189.00	—	—	—	—
48 x 60	AW4860	185.00	OW4860	208.00	—	—	—	—
48 x 72	AW4872	204.00	OW4872	231.00	AWC4872	230.00	OWC4872	250.00
48 x 96	AW4896	240.00	OW4896	273.00	AWC4896	270.00	OWC4896	290.00
48 x 120*	AW48120	360.00	OW48120	395.00	—	—	—	—
48 x 144*	AW48144	390.00	OW48144	420.00	—	—	—	—

- 3/4" Aluminum Trim
- 1" Wood Trim
- 1 1/4" Tray Aluminum
- 2 1/4" Tray Aluminum
- 1 1/4" Tray Wood
- 1 1/4" Wide White Oak Trim Wood (oil finish)

*120" and 144" Melamine markerboards will have white aluminum joints in center



Walker Show-Off Chalk Talkers & Combo Boards



Show-Off Chalk Talkers

- Built with Walker toughness for rugged use
- 1/4" thick chalkboard
- Satin anodized-aluminum or hardwood frames
- ACs and WCBs feature 1/4" wide tray on first 3 sizes; the rest are 2/4" wide trays
- OCs and OCBs feature 1 3/4" deep trays
- Available in green or black
- Attached folding hangers
- Writing surface is quality simulated slate using state-of-the-art synthetics
- Easy-to-clean, washable, attractive

Show-Off Combo Chalk Talkers

- Double duty board combining chalk and natural cork
- Perfect for high traffic areas with limited space needing message centers
- Standard wood finishes page 2

Options:

- Custom Stain – add \$70.00 or 20%, whichever is greater, see page 2 for custom wood stains
- **Custom Sizes** – boards may be ordered in custom sizes or with minor alterations; take the price of the next largest size and add \$70.00 or 20%, whichever is greater



Folding attached hangers come standard



H x W (in.)	Chalkboards Alum. Frame		Chalkboards Oak Frame		Comb. Board Alum. Frame		Comb. Board Oak Frame	
	Alum. Frame	List	Oak Frame	List	Alum. Frame	List	Oak Frame	List
18 x 24	AC1824	36.00	OC1824	41.00	—	—	—	—
24 x 36	AC2436	53.00	OC2436	58.00	WCB2436	85.00	OCB2436	88.00
36 x 48	AC3648	82.00	OC3648	88.00	WCB3648	115.00	OCB3648	123.00
36 x 60	AC3660	166.00	OC3660	184.00	—	—	—	—
48 x 60	AC4860	174.00	OC4860	204.00	—	—	—	—
48 x 72	AC4872	187.00	OC4872	225.00	WCB4872	239.00	OCB4872	248.00
48 x 96	AC4896	237.00	OC4896	270.00	WCB4896	289.00	OCB4896	299.00
48 x 120*	AC48120	335.00	OC48120	360.00	—	—	—	—
48 x 144*	AC48144	350.00	OC48144	399.00	—	—	—	—

1/4" Trim / 1/4" Tray Aluminum

3/4" Trim / 2/4" Tray Aluminum

1" Trim / 1/4" Tray Wood

1 3/4" Trim / 1/4" Tray Wood

*120" and 144" chalkboards available in green only. Specify black or green chalkboard.



Walker Show-Off Reversible Boards



Show-Off Reversible Boards

- Standard quality melamine marker, natural cork and chalkboards
- Reversible
- Choice of materials for both sides
- 2 locking and 2 non-locking casters included
- Standard wood frame is heavy duty white oak with oil finish
- Overall height with casters 72" and 78"
- Markerboard complete with 4 markers and eraser

Options:

- Wood frame options, see page 2:
 - Custom stains add \$180 each, see page 2 for custom stains
 - No maple or red oak

The Best Wood Stands

Heavy duty, rugged stands. Rubber-wheeled casters won't shatter when rolling over expansion joints and rough surfaces.



2 locking and 2 non-locking heavy duty casters included

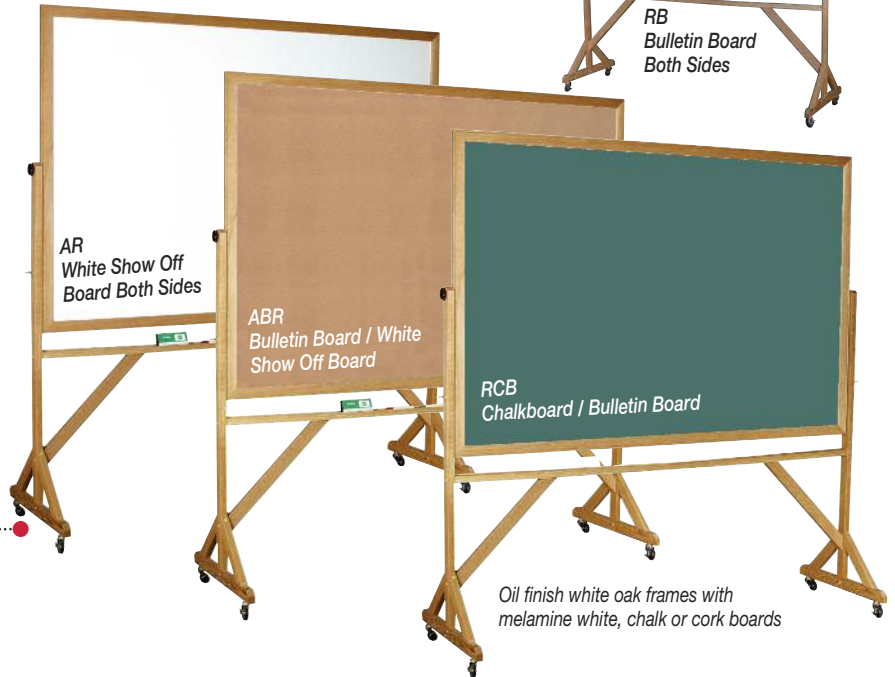

Oil finish white oak frames with melamine white, chalk or cork boards



H x W (in.)	Wood Frames Natural Finish**									
	Chalk Both Sides*		Chalk & Bulletin*		Bulletin Both Sides		White Show-Off Both Sides**		White Show-Off & Bulletin**	
	List	List	List	List	List	List	List	List	List	
36 x 48	R3648	460.00	RCB3648	520.00	RB3648	495.00	AR3648	485.00	ABR3648	520.00
36 x 60	R3660	520.00	RCB3660	560.00	RB3660	530.00	AR3660	530.00	ABR3660	575.00
48 x 72	R4872	536.00	RCB4872	596.00	RB4872	570.00	AR4872	590.00	ABR4872	628.00

* Specify black or green chalkboard when ordering

** Complete with 4 color markers and eraser



QUALITY

“All in the Details”

Mitered Corners

Compare our oak wood frames with the competition; check to see if the corners are mitered, free of burrs, square and flush without gaps. Walker products offer quality front to back.

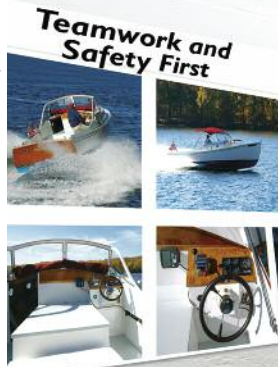

Washable vinyl ~ Color: Breakwater (see page 2 for color chart)

OB bulletin board / oak wood frame with natural cork



The real thing ~ natural cork's small particle resilient surface heals instantly

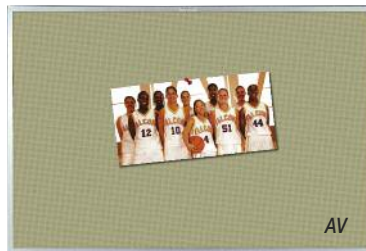

AV bulletin board / aluminum trim, Bayberry Vinyl, see page 2 for color chart

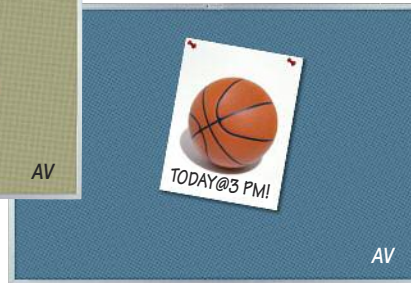

AV bulletin board / aluminum trim, Blue Saga Vinyl, see page 2 for color chart

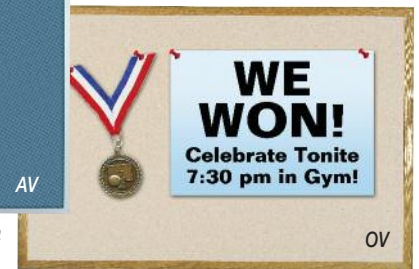

OV bulletin board / oak wood trim, Antique White Vinyl; see page 2 for color chart

Show-Off Bulletin Boards

- Available with satin anodized-aluminum or solid oak frames
- Folding hangers
- Mitered Corners
- Larger wood frame (1" and 1 3/4")
- Vinyl tackboard offers washable colored surface (see vinyl color selection page 2) using 30-40% heavier, more durable vinyl than competition
- Vinyl tackboard is Class A fire-rated surface
- High quality small particle cork; resilient surface seals instantly

Options:

- Custom Stain – add \$70.00 or 20%, whichever is greater; see color chart page 2
- Custom Sizes – boards may be ordered in custom sizes or with minor alterations; take the price of the next largest size and add \$70.00 or 20%, whichever is greater



H x W (in.)	Cork with Alum. Frame		Cork with Oak Frame		Vinyl with Alum. Frame		Vinyl with Oak Frame	
		List		List		List		List
12 x 36	—		OB1236	39.00	—		—	
18 x 24	AB1824	34.00	OB1824	37.00	AV1824	49.00	OV1824	54.00
24 x 36	AB2436	47.00	OB2436	53.00	AV2436	69.00	OV2436	73.00
36 x 48	AB3648	75.00	OB3648	83.00	AV3648	105.00	OV3648	120.00
48 x 48	AB4848	124.00	OB4848	152.00	AV4848	170.00	OV4848	195.00
36 x 60	AB3660	132.00	OB3660	160.00	AV3660	180.00	OV3660	206.00
48 x 60	AB4860	151.00	OB4860	188.00	AV4860	190.00	OV4860	224.00
48 x 72	AB4872	156.00	OB4872	212.00	AV4872	220.00	OV4872	260.00
48 x 96	AB4896	189.00	OB4896	246.00	AV4896	265.00	OV4896	315.00
48 x 120	AB48120	280.00	OB48120	350.00	AV48120	370.00	OV48120	414.00
48 x 144	AB48144	305.00	OB48144	380.00	AV48144	420.00	OV48144	460.00

3/4" Trim Aluminum

1" Trim Wood

1 3/4" Trim Wood



Walker Headliner Porcelain White-Rite Boards



Headliner Porcelain White-Rite Boards

- Porcelain enamel surface permanently fired onto 28 gauge steel
- Standard high gloss white surface, 6100H
- Fade-proof, stain-proof, resists scratches
- Holds magnets
- Standard heavy duty satin anodized aluminum or oil finish white oak trim and trays; dark bronze anodized available
- Concealed mounting hardware, screws included
- Full-length tray
- 1 3/4" wide white oak trim, oil finish, mitered corners with full-length 2 1/4" deep tray
- 4 color markers and 1 eraser

Options:

- High gloss white porcelain is standard. All others subject to a 12% upcharge, \$75 maximum
- Wood frame options:
 - > Red oak with poly finish – add \$2.50 per linear foot of perimeter trim and tray to WRW price
 - > Satin or gloss maple with poly finish – add \$4.00 per linear foot of perimeter trim and tray to WRW price
- Optional 1" cork aluminum maprail available for all units – add \$4.50 per linear foot
- Available with dark bronze anodized – add \$4.00 per linear foot of perimeter trim, tray and maprail
- Available with cherry and dark red mahogany stains – add 20% or \$70, whichever is greater, see page 2 for custom stains
- **Custom Sizes** – boards may be ordered in custom sizes or with minor alterations; take the price of the next largest size and add \$70.00 or 15%, whichever is greater
- Call for multiple board pricing on non-standard boards
- Call for pricing on 5' high boards up to 16' long

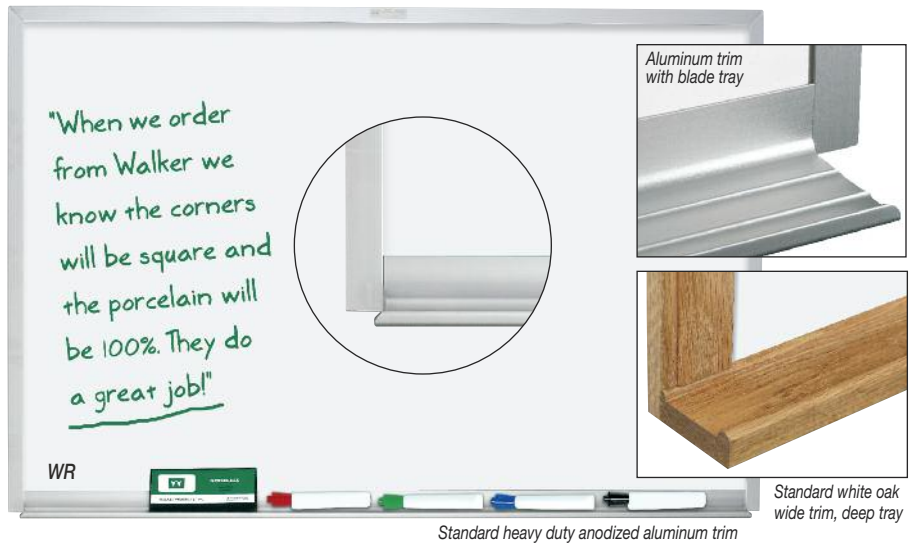

H x W (ft.)	Aluminum Frame		Oak Frame Oil Finish*	
	Frame	List	Frame	List
1 1/2 x 2	WR1824	95.00	WRW1824	115.00
2 x 3	WR23	150.00	WRW23	170.00
3 x 4	WR34	240.00	WRW34	265.00
3 x 5	WR35	350.00	WRW35	386.00
4 x 4	WR44	324.00	WRW44	368.00
4 x 5	WR45	370.00	WRW45	405.00
4 x 6	WR46	398.00	WRW46	476.00
4 x 8	WR48	504.00	WRW48	582.00
4 x 10	WR410	695.00	WRW410	740.00
4 x 12	WR412	800.00	WRW412	860.00
4 x 16	WR416	1140.00	WRW416	1224.00

□ 3/4" Trim, 2 1/4" Tray Aluminum

□ 1 3/4" Trim, 2 1/4" Tray Wood

*Available with custom stains

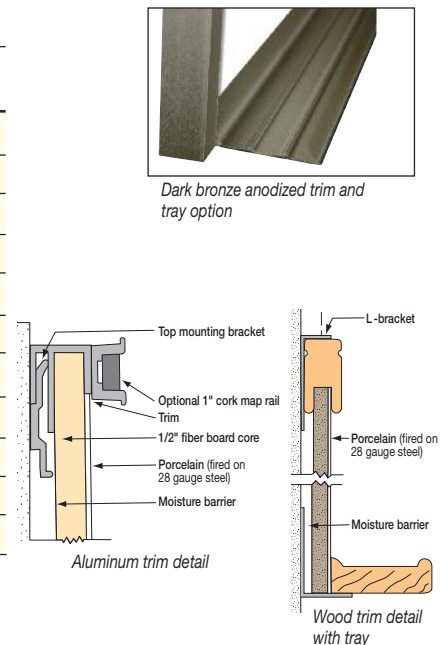

WHY PORCELAIN ENAMEL?

“Because it’s the Best”

Proven Materials

In 30 years, on over 5,000,000 square feet of porcelain enamel, we have never had a writing surface fail. We use only the finest porcelain to give our customers 100% satisfaction. It doesn’t get any better than this!

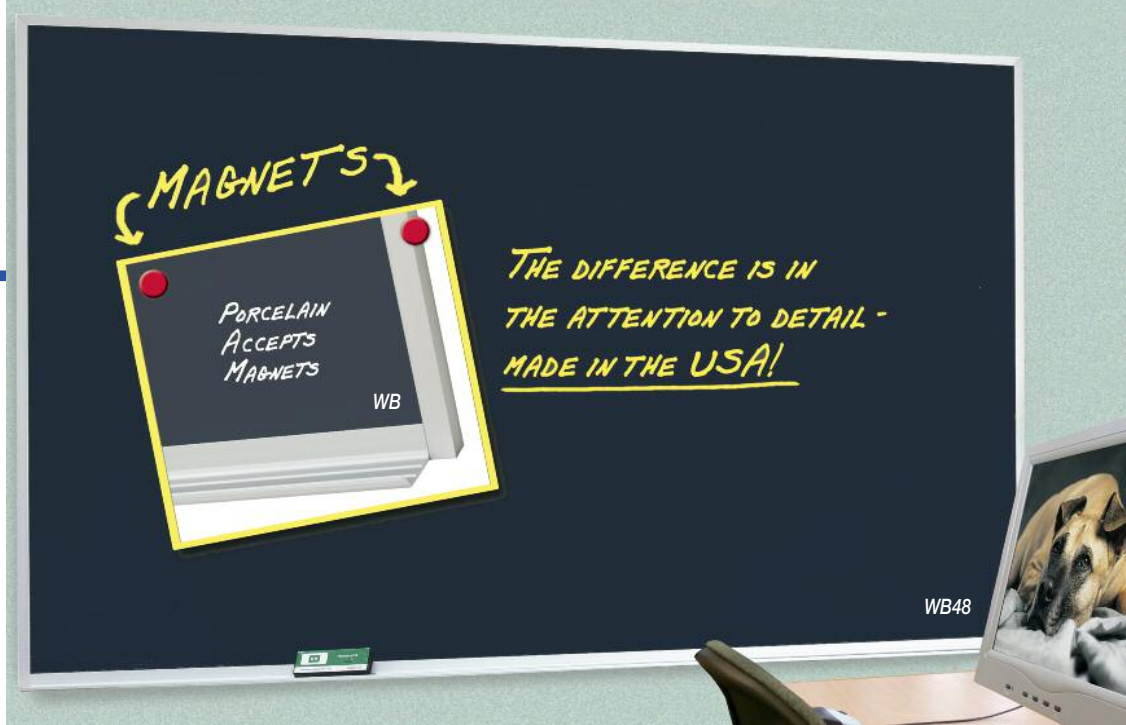

Headliner Porcelain Enamel Chalk & Combo Boards

- Flawless porcelain fired on 28 gauge steel – lifetime of use, lifetime guarantee
- Standard heavy duty satin anodized aluminum or oil finish white oak trim and trays; dark bronze anodized available
- Full-length tray
- Concealed mounting hardware, screws included
- Available in green, jet black or slate grey porcelain, see page 25

Options:

- Wood frame options:
 - > Red oak with poly finish – add \$2.50 per linear foot of perimeter trim and tray
 - > Satin or gloss maple with poly finish – add \$4.00 per linear foot of perimeter trim and tray
- Optional 1" cork aluminum maprail available for all units – add \$4.50 per linear foot
- Available with dark bronze anodized – add \$4.00 per linear foot of perimeter trim, tray and maprail
- Available with cherry stain and dark red mahogany stains – add 20% or \$70, whichever is greater; see page 2
- **Custom Sizes** – boards may be ordered in custom sizes or with minor alterations; take the price of the next largest size and add 20% or \$70.00, whichever is greater; see page 2 for custom stains



WBW23 / Slate Grey Porcelain 6502U
White Oak Trim with oil finish



WBC23 / Aluminum Trim
Green Porcelain 6500U
FORBO® 2182

WB Inset is Slate Grey Porcelain 6502U;
WB48 is Jet Black Porcelain 6501U

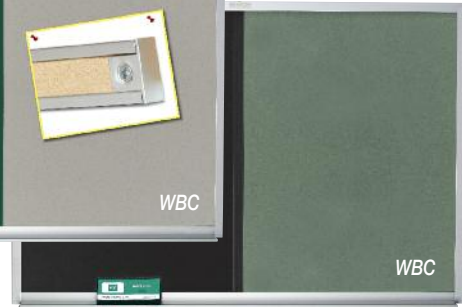

WBC23 / Aluminum Trim / 6501U Black Porcelain
FORBO® 2203



Ultra Matte Porcelain Chalkboard Colors



6500U Green 6501U Jet Black 6502U Slate Grey

H x W (ft.)	Chalkboard Alum. Frame		Combo Chalk & Bulletin Board Alum. Frame*		Chalkboard Oak Frame	
	Code	List	Code	List	Code	List
2 x 3	WB23	155.00	WBC23	175.00	WBW23	180.00
3 x 4	WB34	260.00	WBC34	280.00	WBW34	280.00
4 x 4	WB44	336.00	WBC44	344.00	WBW44	379.00
4 x 5	WB45	380.00	WBC45	395.00	WBW45	425.00
4 x 6	WB46	430.00	WBC46	450.00	WBW46	490.00
4 x 8	WB48	530.00	WBC48	565.00	WBW48	596.00
4 x 10	WB410	725.00	WBC410	735.00	WBW410	760.00
4 x 12	WB412	830.00	WBC412	840.00	WBW412	875.00
4 x 16	WB416	1140.00	WBC416	1150.00	WBW416	1224.00

□ 3/4" Trim, 2 1/4" Tray
Aluminum

□ 1 3/4" Trim, 2 1/4" Tray
Wood

*Specify FORBO® cork linoleum color, size and placement of tackboard on combination units

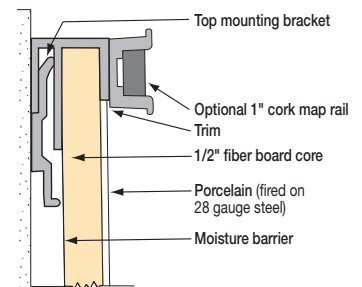

Walker Headliner detail (see page 22 for additional maprail and accessories).



THE BEST MATERIALS

“Integrity”

FORBO® Cork Linoleum

The most durable bulletin board available. Resilient tackable 1/4" surface constructed of natural materials and is washable. Self-heals and does not crack, dry, peel or crumble. Tacks insert easily and are gripped firmly. Available in 12 decorator colors, see page 2 for reference chart.



Reversible boards...take your pick of white-rite or chalk porcelain and FORBO® cork



The Best Aluminum and Wood Stands

Heavy duty, rugged stands. Our aluminum is 50% thicker than many of our competitors'. Rubber-wheeled casters won't shatter when rolled over expansion joints and rough surfaces. 2 locking and 2 non-locking heavy duty casters included.



Headliner Reversible Boards

- Finest Porcelain White-Rite, Porcelain Chalk and FORBO® Cork Linoleum Boards all on wheels for convenient mobility
- Flip side doubles display space
- Choice of materials for both sides
- Standard markerboard is 6100H white
- Standard porcelain chalkboard colors are 6500U green and 6502U slate grey
- Heavy duty stands insure proper rigidity under rigorous use
- Metal locks hold board firmly in position
- 2 locking and 2 non-locking casters included
- Standard wood frame is heavy duty white oak with oil finish
- Aluminum frame most durable – lasts a lifetime
- Overall height with casters 72" and 78"
- White-Rite Boards come with 4 color markers and eraser

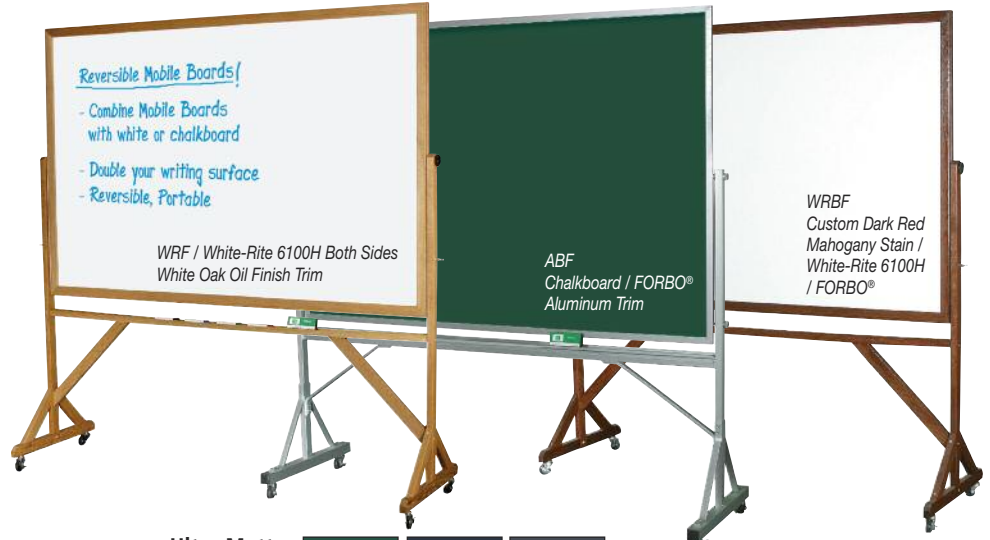

Ultra Matte Porcelain Chalkboard Colors

6500U Green	6501U Jet Black	6502U Slate Grey
-------------	-----------------	------------------



H x W (ft.)	Oak Wood Frame - Porcelain							
	Chalk Both Sides*		Chalk* & Bulletin**		White-Rite Both Sides		White-Rite & Bulletin**	
	List	List	List	List	List	List	List	
3 x 4	WF34	722.00	WBF34	722.00	WRF34	722.00	WRBF34	722.00
3 x 5	WF35	882.00	WBF35	882.00	WRF35	882.00	WRBF35	882.00
4 x 6	WF46	990.00	WBF46	990.00	WRF46	990.00	WRBF46	990.00



H x W (ft.)	Aluminum Frame - Porcelain							
	Chalk Both Sides*		Chalk* & Bulletin**		White-Rite Both Sides		White-Rite & Bulletin**	
	List	List	List	List	List	List	List	
3 x 4	AF34	2112.00	ABF34	2112.00	ARF34	2112.00	ARB34	2112.00
3 x 5	AF35	2370.00	ABF35	2370.00	ARF35	2370.00	ARB35	2370.00
4 x 6	AF46	2475.00	ABF46	2475.00	ARF46	2475.00	ARB46	2475.00

* When ordering chalkboards specify green 6500U, jet black 6501U, or slate grey 6502U

** Specify FORBO® cork linoleum bulletin board; see page 2 for color selection

Options:

- Markerboard: white 6100H is standard; other colors available, see page 25
- FORBO® cork color selection see page 2
- Available on special order: any combination of chalkboards, FORBO®cork, vinyl tackboards, and White-Rite boards
- Add \$180.00 for custom stains, see page 2 for wood finish standard selection
- Additional porcelain color surfaces available – add 10% (\$75 maximum) for low glare writing surfaces, see page 25





Headliner Bulletin & Porcelain Combo White-Rite Boards

- Most rugged tackboard built
- Framed in heavy-duty satin anodized aluminum or white oak with oil finish
- Concealed hardware, screws included
- 1/4" thick burlap-backed, high-density, self-sealing FORBO® cork will last indefinitely
- FORBO® cork is washable
- 6100H white porcelain is standard on combination boards

Options:

- FORBO® cork linoleum color selection see page 2
- Anodized bronze frame add \$4.00 per linear foot of perimeter trim, tray and maprail
- Wood frame options, see page 2:
 - > Red oak with poly finish – add \$1.00 per linear foot of perimeter trim and tray to WCW price
 - > Satin and gloss maple with poly finish – add \$3.50 per linear foot of perimeter trim and tray to WCW price
- Custom stain - add 20% or \$60, whichever is greater to WCW price
- **Custom Sizes** – boards may be ordered in custom sizes or with minor alterations; take the price of the next largest size and add \$70.00 or 15%, whichever is greater

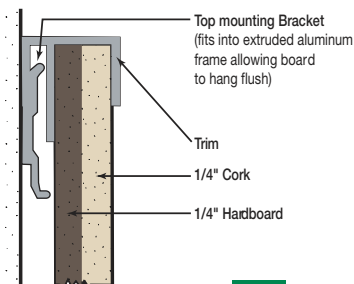

H x W (ft.)	Bulletin Board* Alum. Frame		White-Rite & Bulletin Board* Alum. Frame		Bulletin Board* Oak Frame	
	Code	List	Code	List	Code	List
2 x 3	WC23	126.00	WRC23	181.00	WCW23	136.00
3 x 4	WC34	230.00	WRC34	300.00	WCW34	255.00
4 x 4	WC44	301.00	WRC44	345.00	WCW44	335.00
4 x 5	WC45	385.00	WRC45	390.00	WCW45	410.00
4 x 6	WC46	445.00	WRC46	498.00	WCW46	485.00
4 x 8	WC48	570.00	WRC48	656.00	WCW48	640.00
4 x 10	WC410	680.00	WRC410	775.00	WCW410	730.00
4 x 12	WC412	824.00	WRC412	910.00	WCW412	895.00
4 x 16	WC416	1045.00	WRC416	1240.00	WCW416	1160.00

3/4" Trim, 2 1/4" Tray Aluminum
 1 3/4" Trim, No Trays Wood

*Specify FORBO® cork color, size and placement of tackboard on combination units



Closeup of mitered corner on satin maple finish wood frame and FORBO® cork 2185



Walker Headliner White-Rite Grid Boards

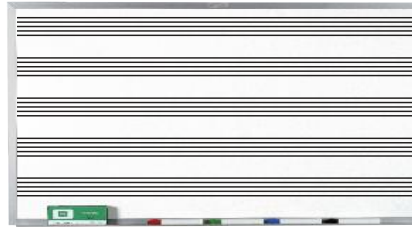

Music Staff
Line Thickness 1/16"

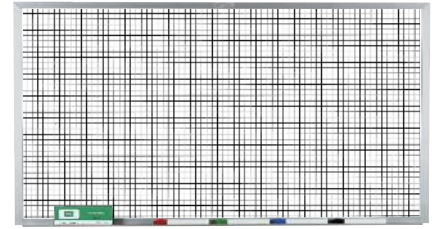

1" x 1" Grid
Line Thickness 1/32"

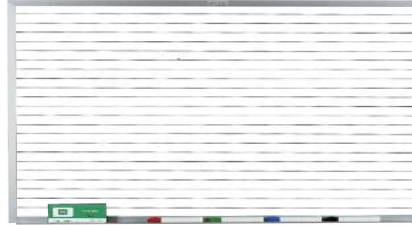

Horizontal Lines
Line Thickness 1/32"

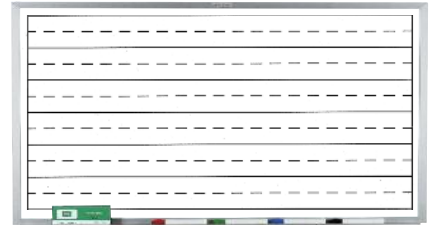

Penmanship Lines
Line Thickness 1/16"



USA Map
Line Thickness 1/64", 3/32"

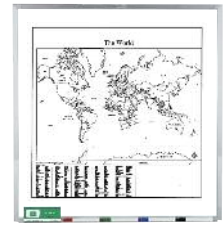

World Map
Line Thickness 1/64", 3/32"

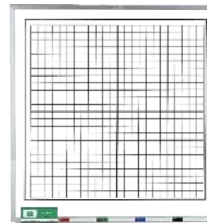

Graph Coordinates
Line Thickness 1/32"

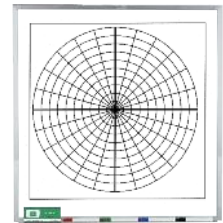

Polar Coordinates
45" Outside Diameter

Headliner White-Rite Grid Boards

- Perfect for charts, graphs, scheduling
- Porcelain enamel surface, grids permanently fired onto surface – will never come off
- Resists scratches
- Holds magnets
- Heavy duty satin anodized aluminum trim and trays
- Concealed mounting hardware, screws included
- Full-length tray
- 4 color markers and 1 eraser

Options:

- White-Rite music staves in stock, all other graphics and grids available by special order
- Optional 1" cork maprail available – add \$4.50 per linear foot
- Available with dark bronze anodized frame - add \$4.00 per linear foot of perimeter trim, tray and maprail



Grids permanently fired onto surface

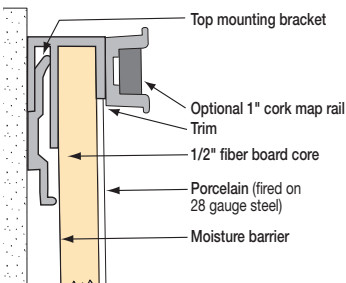
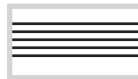

Item	#6100H White Sizes Available	#6502U Black Sizes Available	#6500U Green Sizes Available	PRICING	
				Size	WRG White Porcelain WBG Chalk Porcelain
Music Stuffs	4' x 4' -5' -6' -8' -10' -12'	4' x 4' -5' -6' -8' -10'	4' x 4' -5' -6' -8' -10'	4' x 4'	425.00
1" x 1" Grids	4' x 6' / 4' x 8'	NA	NA	4' x 5'	515.00
Horizontal Lines	4' x 6' / 4' x 8'	NA	NA	4' x 6'	583.00
Graph Coordinates	4' x 4'	4' x 4'	4' x 4'	4' x 8'	735.00
Penmanship Lines	4' x 4' -6' -8' -10'	4' x 4' -6' -8' -10'	4' x 4' -6' -8' -10'	4' x 10'	910.00
Polar Coordinates	4' x 4'	4' x 4'	4' x 4'	4' x 12'	1070.00
USA Map	4' x 4'	4' x 4'	4' x 4'		
World Map	4' x 4'	NA	NA		

* Specify: Surface code (WRG - White Porcelain; WBG - Chalk Porcelain), surface color, grid type and size

Example:

Surface	Size	Color	Grid Type
WRG	4' x 10'	6100H White	Music Stuffs



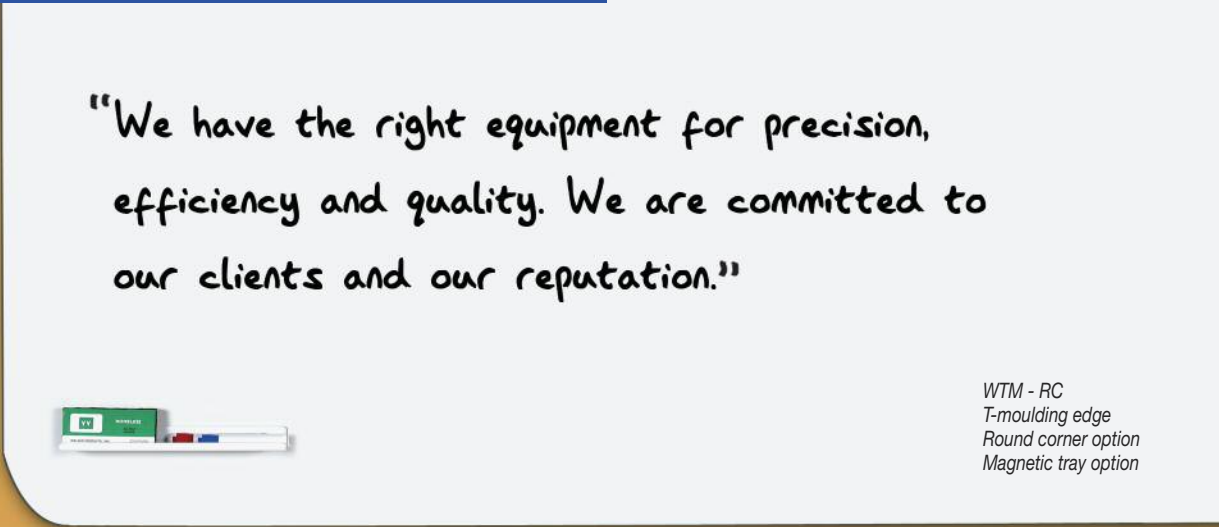

“We have the right equipment for precision, efficiency and quality. We are committed to our clients and our reputation.”

WTM - RC
T-moulding edge
Round corner option
Magnetic tray option

Headliner Frameless Porcelain Boards

- Porcelain enamel surface permanently fired onto 28 gauge steel
- Fade-proof, stain-proof, and highly scratch-resistant
- Holds magnets
- White painted or white T-moulding edge
- Square corners are standard (round corners available – see below)
- Clean look – no frame to clash with décor
- Tray options listed below
- Double full-length Z-bars for wall and board

Options:

- Must specify RC (round corner) or SQ (square corner); square corner is standard
- Porcelain colors available: see color selection page 25
- Round corners add \$70 total per board
- All full-length trays are permanently attached:
 - > Full-length white aluminum tray – add \$9.00 per l.f.
 - > Full-length satin aluminum tray – add \$9.00 per l.f.
 - > Full-length maple tray – add \$11.00 per l.f.
 - > Full-length red oak, poly tray – add \$10.00 per l.f.
 - > Full-length custom stain oak trays: add \$13.00 per l.f., see custom stains page 2.
- 18" white aluminum tray, attaches magnetically: \$40.00 each
- **Custom Sizes** – boards may be ordered in custom sizes or with minor alterations; take the price of the next largest size and add \$70.00 or 15%, whichever is greater

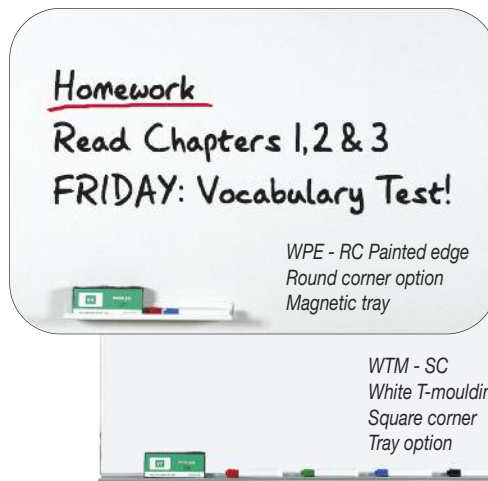

Homework
Read Chapters 1, 2 & 3
FRIDAY: Vocabulary Test!

WPE - RC Painted edge
Round corner option
Magnetic tray

WTM - SC
White T-moulding
Square corner
Tray option

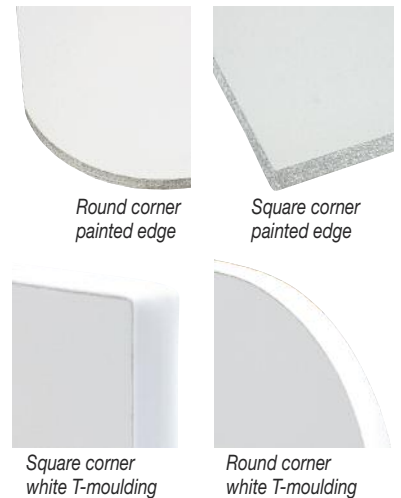

Round corner painted edge

Square corner painted edge

Square corner white T-moulding

Round corner white T-moulding



Magnetic white aluminum tray option

H x W (ft.)	Painted Edge		White T-Moulding Edge	
	Edge	List	Edge	List
3 x 4	WPE34	310.00	WTM34	310.00
4 x 4	WPE44	410.00	WTM44	410.00
3 x 5	WPE35	490.00	WTM35	490.00
4 x 5	WPE45	515.00	WTM45	515.00
4 x 6	WPE46	562.00	WTM46	562.00
4 x 8	WPE48	720.00	WTM48	720.00
4 x 10	WPE410	905.00	WTM410	905.00
4 x 12	WPE412	1028.00	WTM412	1028.00
4 x 16	WPE416	1430.00	WTM416	1430.00

Square corners (SC) are standard, round corner (RC) is optional; please specify

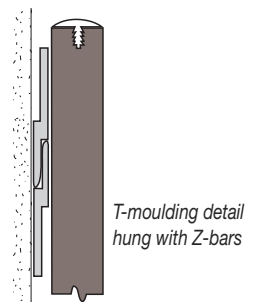

T-moulding detail hung with Z-bars



Above: Round corner, beveled edge; Guilford of Maine Wedgewood fabric

Radii Fabric-Covered Communication Boards

- Contemporary designer look
- Heavy duty 1" thick with round corner and beveled edges are standard; square corner non-beveled edge available – please specify
- Hung with full-length Z-bars for wall and board
- 15 stock colors, many more available, see page 34
- Fabric is Class A fire-rated Guilford of Maine 701-2100

Also available in customer supplied fabric



H x W (ft.)	Radii Fabric Bulletin Boards	List
1 1/2 x 2	DSF1824*	98.00
1 1/2 x 3	DSF1836*	140.00
2 x 3	DSF2436*	150.00
1 1/2 x 4	DSF1848*	195.00
3 x 4	DSF3648*	260.00
1 1/2 x 5	DSF1860*	215.00
3 x 5	DSF3660*	320.00
4 x 4	DSF4848*	320.00
4 x 5	DSF4860*	350.00
4 x 6	DSF4872*	425.00
4 x 8	DSF4896*	535.00
4 x 10	DSF48120*	650.00
4 x 12	DSF48144*	740.00

*Please specify: Rounded corners and beveled edges are standard, please specify if square corners or non-beveled edges
 Note: All boards 2' x 3' and smaller can be shipped UPS

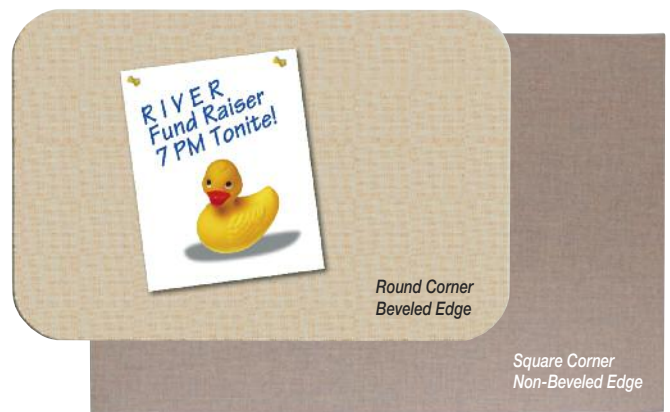

Guilford of Maine Bone fabric (top), Guilford of Maine Rose Quartz fabric (bottom). See page 34 for available fabric colors.

Options:

- Square corner non-beveled edges available
- Standard boards are Class A fire-rated fabric on 1" thick Class C fire-rated bulletin board. Please add \$3.00 per s.f. for Class A fire-rated core material (minimum add for Class A fire-rated core is \$20.00)
- Additional colors available from Guilford of Maine's FR701 style 2100 for a one time charge of \$60.00 total
- Other fabric brands available on custom order
- Tackboards may also be fabricated from customer-supplied material, call for details
- **Custom Sizes** – boards may be ordered in custom sizes or with minor alterations; take the price of the next largest size and add 10% or \$40.00, whichever is greater

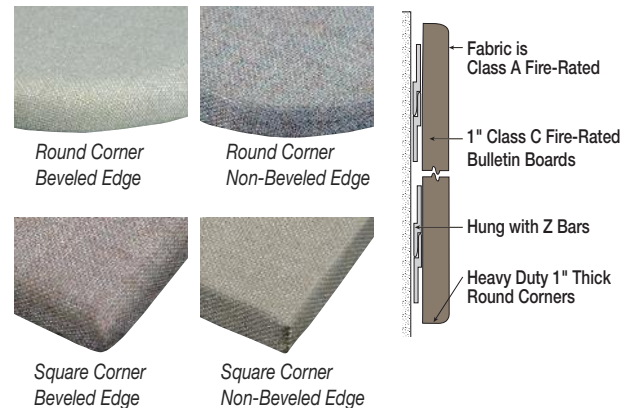

Walker Headliner Radii White-Rite & Chalkboards

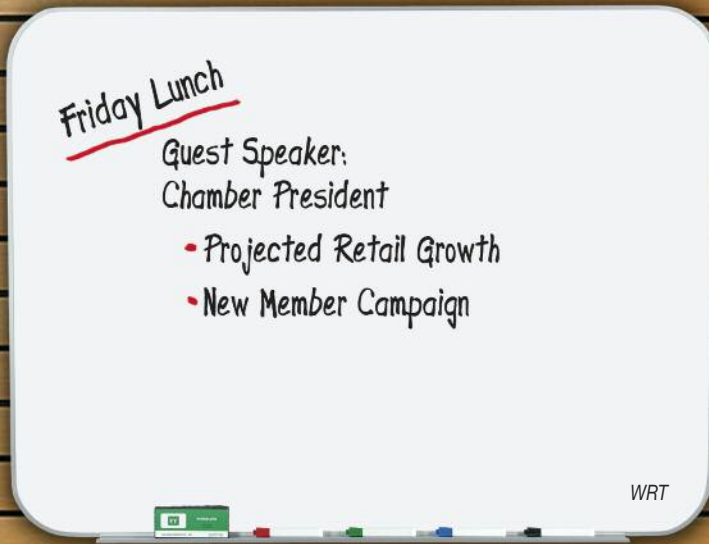

Radii White-Rite & Chalkboards

- Contemporary designer look, unique item
- Flawless porcelain marker and chalkboards
- Heavy duty aluminum frames
- Radii White-Rite Boards:
 - > Fired on Porcelain enamel finish
 - > Complete with 4 markers and 1 eraser
 - > Concealed mounting hardware, screws included
- Radii Chalkboards:
 - > See porcelain color selection chart on page 25
 - > Porcelain enamel on steel will never stain, discolor, or lose its erasability
 - > Porcelain enamel on steel; holds magnets
 - > Available with maprail

Options:

- Bronze trim, tray and maprail available for additional charge; add \$4.00 per linear foot
- Optional 1" cork maprail available – add \$4.50 per linear foot
- Custom sizes not available in round corner aluminum trim



Heavy duty 7/8" thick aluminum frames; slate grey 6502U porcelain chalkboard shown here

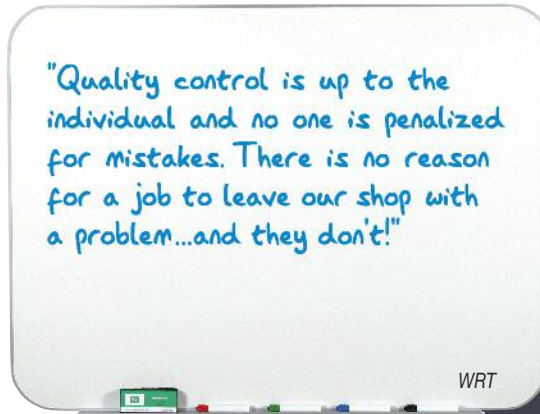

WBT
Chalkboard Porcelain, slate grey 6502U
Option: bronze trim
Option: FORBO® 2187 maprail

Ultra Matte Porcelain Chalkboard Colors

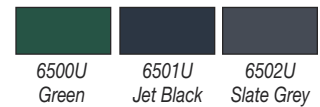

WBT
Chalkboard Porcelain, green 6500U



Heavy duty 2 1/2" tray comes standard on all radii marker or chalkboards

H x W (ft.)	Radii White-Rite Boards		Radii Chalk Boards	
	Code	List	Code	List
2 x 3	WRT23	208.00	WBT23	208.00
3 x 4	WRT34	320.00	WBT34	320.00
3 x 5	WRT35	460.00	WBT35	460.00
4 x 4	WRT44	420.00	WBT44	420.00
4 x 5	WRT45	495.00	WBT45	495.00
4 x 6	WRT46	565.00	WBT46	565.00
4 x 8	WRT48	700.00	WBT48	700.00

Porcelain chalkboard may be ordered in 6500U green, 6502U Slate Grey or 6501U Jet Black



Headliner Enclosed Bulletin & Directory Boards



Aluminum Headliner Enclosed Bulletin & Directory Boards

- Enclosed units have 1/4" thick tempered glass doors with full-length hinges
- Key locked doors
- Bulletin Boards – see color chart for FORBO® Cork on page 2
- Directory Boards faced in rich black felt
- Heavy duty aluminum frames
- 2" deep overall
- Concealed mounting hardware, screws included

Options:

- Custom sizes available – call for pricing
- Bulletin boards also available with Guilford of Maine fabric, see page 34



H x W (ft.)	Number of Doors	Bulletin Alum. Frame		Black Felt Directory Alum. Frame	
		List	List	List	List
3 x 2	1	BC32	790.00	WGD32	860.00
3 x 4	2	BC34	1246.00	WGD34	1376.00
3 1/2 x 5	2	BC365	1500.00	WGD365	1720.00
4 x 6	2	BC46	1700.00	WGD46	1960.00
3 x 2 1/2	1	BC325	890.00	-	-
4 X 8	3	BC48	2480.00	-	-

Solid Oak Enclosed Bulletin & Directory Boards

- Solid white oak, oil finish, 2" deep frames
- Natural cork bulletin boards
- Black felt directories
- Locking acrylic doors
- Concealed mounting hardware, screws included

Options:

- Custom stains available: add \$180:
 - > No red oak or maple, see page 2 for custom stain selections
- FORBO® cork, vinyl or fabric available for additional price
- Custom sizes available – call for pricing

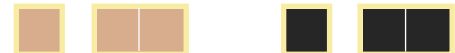

H x W (ft.)	Number of Doors	Natural Cork Bulletin Solid Oak Frame		Black Felt Directory (Lt. Oak Finish)	
		List	List	List	List
2 x 11 1/2	1	WWB2418	320.00	WWD2418	350.00
3 x 2	1	WWB32	410.00	WWD32	510.00
3 x 4	2	WWB34	680.00	WWD34	880.00
3 x 5	2	WWB35	760.00	WWD35	1100.00
4 x 6	2	WWB46	950.00	WWD46	1380.00



White oak oil finish and cork bulletin board is standard



White oak oil finish and directory board is standard

Open Face Aluminum Directory Board

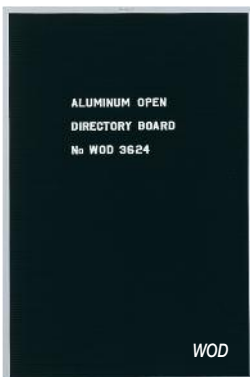

Open face directory

H x W (ft.)	Open Face Alum. Frame Directory	
	Directory	List
3 x 2	WOD3624	235.00
3 x 4	WOD3648	400.00
1 1/2 x 2	WOD1824	146.00
2 x 1 1/2	WOD2418	146.00
2 x 3	WOD2436	235.00
4 x 3	WOD4836	400.00

Walker Changeable Letters

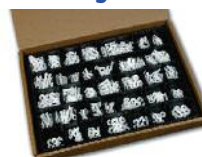

Sizes (in.)	Changeable Letters	List
1/2	WDL30012	90.00
3/4	WDL30034	90.00
1	WDL3001	90.00

All letters are compact in easy-to-use compartmentalized storage box. Assortment includes: 300 white Gothic assorted letters, numbers and punctuation marks, standard changeable letter and figure assortment distribution: 15 - A,I,O; 14 - E,R,S,T; 12 - N; 10 - C,L,M; 9 - F,G,P,H,P; 8 - B,D,1; 7 - K; 6 - J,W,Y,2,5; 4 - V, 3,4,6,7,8,9,0; 3 - e, period, comma; 2 - Q,X,Z & \$.





Sliding Glass Wood & Aluminum Bulletin Board Cases

- 1/4" tempered glass
- 1/4" natural cork on 1/4" hardboard tackboard
- Deluxe plunger type lock in bottom track (not prone to glass breakage like clasp locks)
- Heavy duty aluminum or satin finish oak frame
- 3 1/2" deep overall
- **Custom sizes available** – call for pricing

Options:

- Add for 1/4" FORBO® cork - \$6.00 per s.f., see page 2 for colors
- Add for vinyl on 1/4" natural cork - \$3.50 per s.f., see page 2
- Add for stock Guilford of Maine fabric, see page 34 for colors
- 1/4" natural cork - \$4.50 per s.f.
- Additional wood frame options:
 - > Oak frame custom stains add 15%; see page 2
 - > Maple frame with clear satin finish add 6% to oak base price
- Units may be ordered with 5" depth, call for pricing
- Aluminum units can be ordered recessed, call for pricing



SWC with FORBO® option 2185

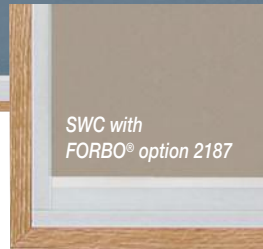

SWC with FORBO® option 2187

Oak satin finish; see page 2 for FORBO® color chart

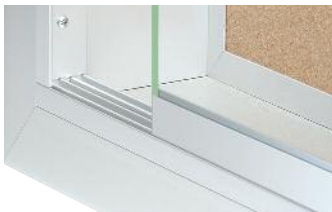

Aluminum frame 5" shown, 3" standard (3 1/2") Maple frame 5" shown, 3 1/2" standard



Aluminum heavy duty trim, tempered glass with deluxe lock; FORBO® 2166, see page 2 for more color options



Satin finish oak frame, tempered glass with deluxe lock

H x W (ft.)	Number of Doors	Tempered Glass Aluminum Frame Bulletin Board Case		Tempered Glass Wood Frame Bulletin Board Case	
		Case	List	Case	List
3 x 4	2	SBC34	1272.00	SWC34	1252.00
4 x 4	2	SBC44	1428.00	SWC44	1390.00
4 x 5	2	SBC45	1740.00	SWC45	1720.00
4 x 6	2	SBC46	1866.00	SWC46	1836.00
4 x 8	2	SBC48	2260.00	SWC48	2225.00
4 x 10	4	SBC410	2940.00	-	-
4 x 12	4	SBC412	3460.00	-	-





Astro Conference Center

- 4' x 4' closed, 4' x 8' open
- Visual work station features large White-Rite porcelain board and 2 natural cork bulletin boards
- Pad holders for additional notes
- Durable high pressure laminate surface in dark walnut, light oak, dark red mahogany
- Scratch resistant, rugged
- Concealed mounting hardware, screws included

Options:

- 4' x 4' concealed projection screen hides under top rail when not in use (PS40): \$96.00
- Paper pads (PS23): \$20.00



Projection screen available; hides inside at top of unit when not in use



H x W (ft.)	Astro Conference Center	List
4 x 8	ACC44	1850.00



Dark Walnut

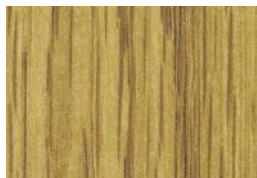

Light Oak



Dark Red Mahogany

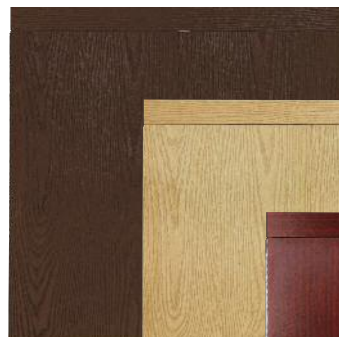

Dark Walnut



Light Oak



Dark Red Mahogany



Walker Architectural Series Horizontal Sliding Markerboards

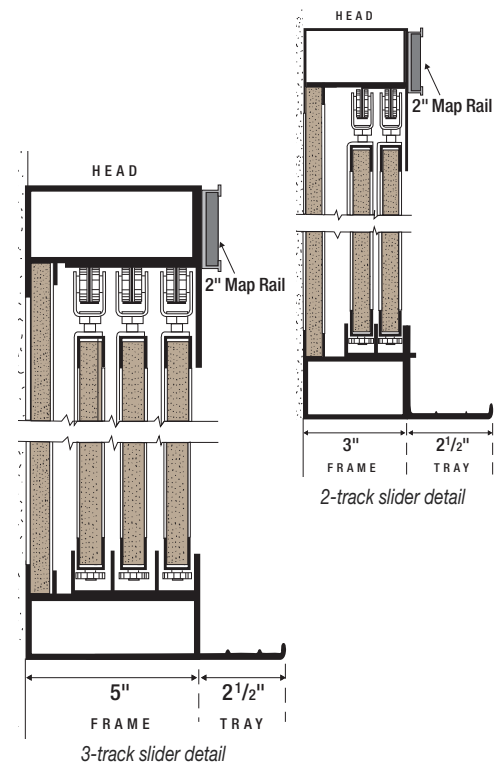
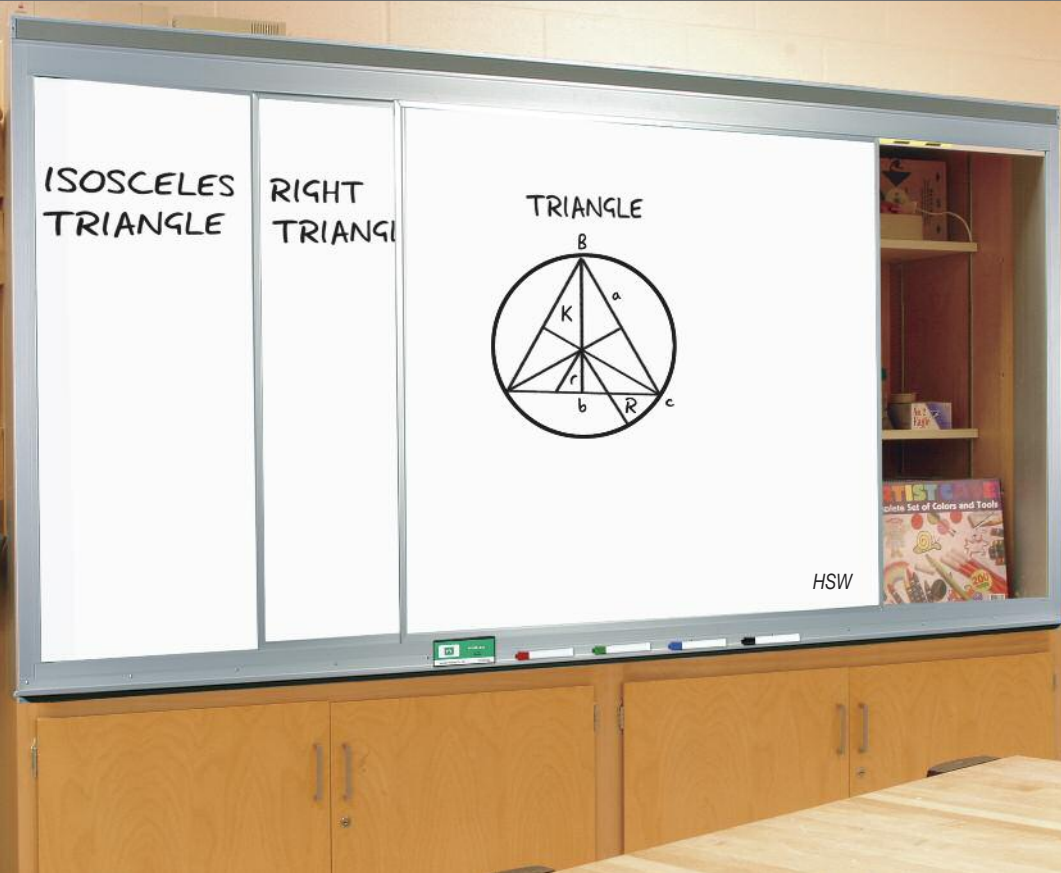

Rugged sliding markerboards increase writing space and can cover storage areas and electronic boards. Unit shown with no back panel for access to shelving

Horizontal Sliding Markerboards

- Double or triple your writing area with a 2- or 3-track horizontal sliding markerboard
- Can be used to cover storage area or electronic copy boards
- Back panel is $\frac{7}{16}$ " particleboard and sliding panels are porcelain on $\frac{1}{2}$ " fiberboard with .015 aluminum backing sheet to keep sliding panels flat and rigid
- Panels slide easily on nylon rollers at top and nylon glides at bottom edge
- Full-length 2" maprails and blade trays are standard; can be ordered without
- 2-track units are on $1\frac{3}{4}$ " by 3" deep outer frames and 3-track units have $1\frac{3}{4}$ " by 5" deep outer frames
- Ships assembled; customer can disassemble to access confined spaces



Sliding units double or triple the amount of writing area and can be used to cover storage areas, electronic boards, monitors or equipment

Options:

- 4-track units can be ordered on 5" outer frames without back panels and on 6" outer frames with back panels on a custom basis, call for pricing
- Deduct for no back panel - \$25.00 per linear foot
- Units can be ordered with openings in back panel for access behind board and for electronic board installation, call for pricing
- **Custom Sizes** and configurations available, call for pricing

H x W (ft.)	2-Track			3-Track				
	Model Number	Number of Sliding Panels	Sliding Panel Size Approx.	List	Model Number	Number of Sliding Panels	Sliding Panel Size Approx.	List
4' x 8'	HSW48-2	2	4' x 4'	3080.00	HSW48-3	3	4' x 4'	3900.00
4' x 10'	HSW410-2	2	4' x 5'	3550.00	HSW410-3	3	4' x 5'	4400.00
4' x 12'	HSW412-2	2	4' x 6'	3900.00	HSW412-3	3	4' x 6'	4800.00
4' x 14'	HSW414-2	4	4' x 3' 6"	4860.00	HSW414-3	6	4' x 3' 6"	5850.00
4' x 16'	HSW416-2	4	4' x 4'	5150.00	HSW416-3	6	4' x 4'	6150.00
4' x 18'	HSW418-2	4	4' x 4' 5"	5770.00	HSW418-3	6	4' x 4' 5"	6875.00
4' x 20'	HSW420-2	4	4' x 5'	6000.00	HSW420-3	6	4' x 5'	7200.00
4' x 24'	HSW424-2	4	4' x 6'	6720.00	HSW424-3	6	4' x 6'	8000.00



Walker Architectural Series Floor-to-Ceiling Horizontal Sliding Units



Floor-to-ceiling horizontal sliding units turn a wall or storage area into a quality markerboard



Rubber rollers provide quiet operation

Floor-to-Ceiling Horizontal Sliding Unit

- Turn any wall into a sliding markerboard
- Standard sliding panel widths are 4'
- Standard heights are 8', 9' and 10'
- Panels are 24- and 28-gauge porcelain markerboards on 1" thick fiberboard with .015 aluminum sheet on the back
- Rolls on bottom track, top track is a guide
- Heavy duty aluminum panel frame 1" x 1¼" with ⅛" wall thickness
- Professional installation required

Options:

- To add a floor-to-ceiling markerboard behind sliding panels, see page 23
- Porcelain colors available, see page 25
- **Custom sizes available** – call for pricing



Heavy duty aluminum frames make these units extremely durable; 1" thick, lightweight panels

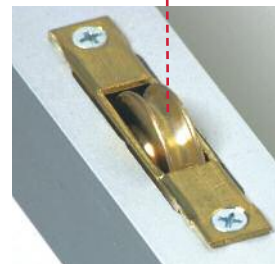

Heavy duty brass bottom rollers

H x W (ft.)	Sliding Panel	List
8 x 4	FCH84	1550.00
9 x 4	FCH94	1680.00
10 x 4	FCH104	1750.00

Track (ft.)	Single Track Assembly Unit*	List
8	TAU8	265.00
12	TAU12	400.00
16	TAU16	510.00
24	TAU24	750.00

* Prices are for single Track Assembly Units. You will need a single Track Assembly Unit (TAU) for each sliding panel track. A TAU consists of 1 top track, 1 bottom track and mounting hardware

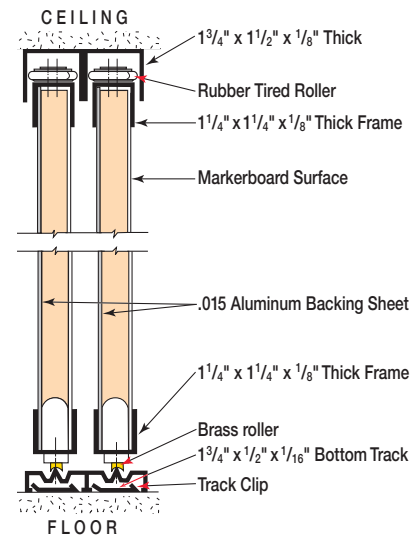

2-Track Unit illustrated (tracks sold separately)



Walker Map, Display Rails & Accessories

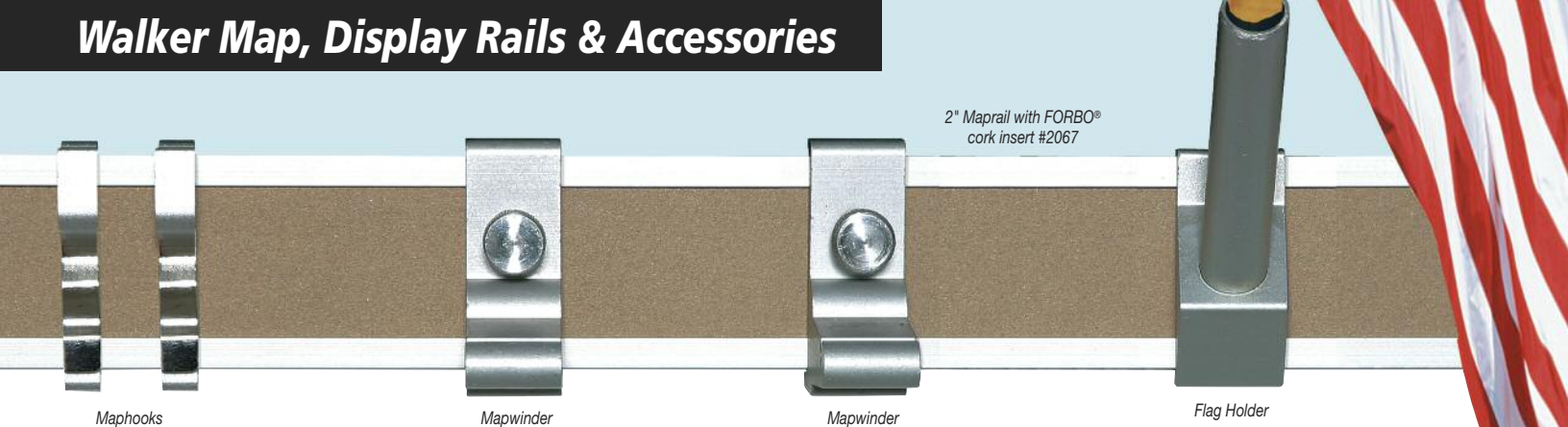

2" Maprail with FORBO® cork insert #2067

Maphooks

Mapwinder

Mapwinder

Flag Holder

Show-Off & Headliner Maprails, and Accessories

- Turn any wall or board into a bulletin board easily and inexpensively
- 1" or 2" maprail easily installed on aluminum trim, wood trim and directly on the wall
- Available in up to 24' lengths; sold by the linear foot
- Standard cork insert is 1/4" burlap-backed FORBO® cork

Walker Maprail with Insert

1" Maprail	Cost Per Linear Foot	2" Maprail	Cost Per Linear Foot	3" Display Rail	Cost Per Linear Foot
Less than 100 l.f.	4.25	Less than 100 l.f.	5.25	Less than 100 l.f.	6.50
100 - 300 l.f.	3.75	100 - 300 l.f.	4.70	100 - 300 l.f.	6.25
300 l.f. and over	3.25	300 l.f. and over	4.25	300 l.f. and over	6.00

Packing charge \$20.00 net for all maprail orders less than 50 linear feet

Walker Maprail Accessories - 1" or 2"

Item	List
1" or 2" Maphooks	2.20 Each
1" or 2" Flag Holders	8.50 Each
1" or 2" Mapwinders	8.50 Set
1" or 2" Maprail Endcaps	3.50 Set
3" Display Rail Endcaps	5.00 Set



2" maprail with (right to left) maprail endstop, maphook, mapwinder set, flag holder; FORBO® 2186



3" Display Rail 2" Maprail 1" Maprail

Above photo of Display Rail and Maprails; FORBO® 2186

Walker Chalkboard & Markerboard Rugged, All Felt Erasers



H x W x T (in.)	Model Number	List
2 x 5 x 1	FE25	3.00 Each
		30.00 Dozen
		250.00 Gross

Walker Dry Erasable Markers Solvent-based for Reduced Ghosting

Model Number	List
DM Black, DM Blue, DM Red, DM Green	2.50 Each
	22.00 Dozen
	250.00 Gross

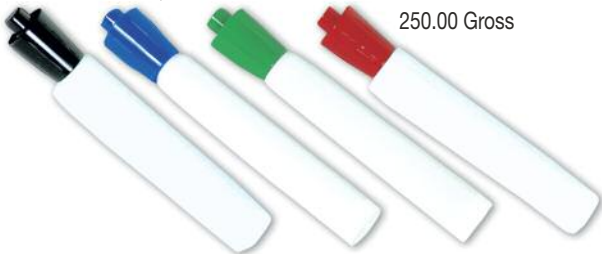

Walker Roll Cork Available in 4', 5' and 6' wide rolls*

Model Number	Item	Thickness	Width	Price Per s.f. for Partial Roll	Full Roll Length Approx.	Price Per s.f. for Full Roll
PGC125	Natural Cork	1/8"	4'	1.30	200 l.f.	1.00
PGC25	Natural Cork	1/4"	4'	2.40	105 l.f.	2.00
PGC25	Natural Cork	1/4"	5', 6'	3.90	98 l.f.	3.40
PFC25	Colored FORBO® Cork	1/4"	4', 6'*	7.00	94 l.f.	6.25

* Check for color availability of 6' goods on page 2. Note: Packing charge \$15.00 net for all orders less than a full roll shipped by commercial carrier. s.f. = square foot / l.f. = linear foot



Walker natural cork available by the roll in 4', 5' and 6' widths



Colored FORBO 2182 cork available by the roll in 4' and 6' widths, see color chart page 2



Walker Headliner Floor-to-Ceiling White Markerboards

Make any wall
a floor-to-ceiling
markerboard

These Architectural series tack walls (with custom fabric shown here), combined with the floor-to-ceiling markerboards, provide maximum flexibility, sound reduction and a great look, see page 31

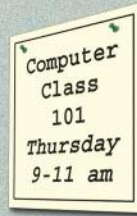

WRP

Floor-to-Ceiling White Porcelain Markerboards

- 6', 8', 9' heights
- 4', 8', 12', 16', 20' lengths
- White painted edges
- Hung with triple full-length Z-bars
- Perimeter edges are color matched
- Joints between panels are concealed splines; no metal strips to interfere with your writing
- Professional installation required



Square Corner Painted Edge



Spline joint...

Options:

- 18" white magnetic trays \$40.00 each
- Custom sizes available - call for pricing
- Porcelain color options page 25
- Add .015 aluminum backing sheet for extra rigidity - \$2.50 extra per square foot

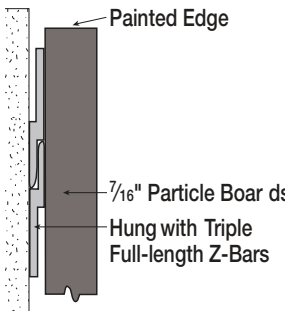
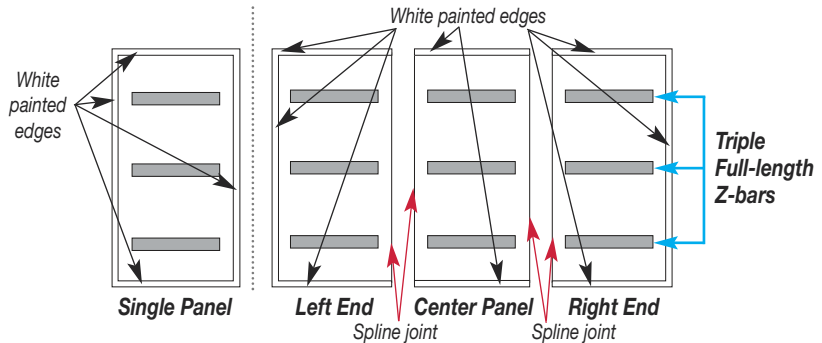

Markerboard panel detail

H x W (ft.)	Single Panel	List	Left End	List	Center Panel	List	Right End	List
6 x 4	WRP64S	580.00	WRP64L	580.00	WRP64C	580.00	aWRP64R	580.00
8 x 4	WRP84S	724.00	WRP84L	724.00	WRP84C	724.00	WRP84R	724.00
9 x 4	WRP94S	875.00	WRP94L	875.00	WRP94C	875.00	WRP94R	875.00

Porcelain color chart see page 25



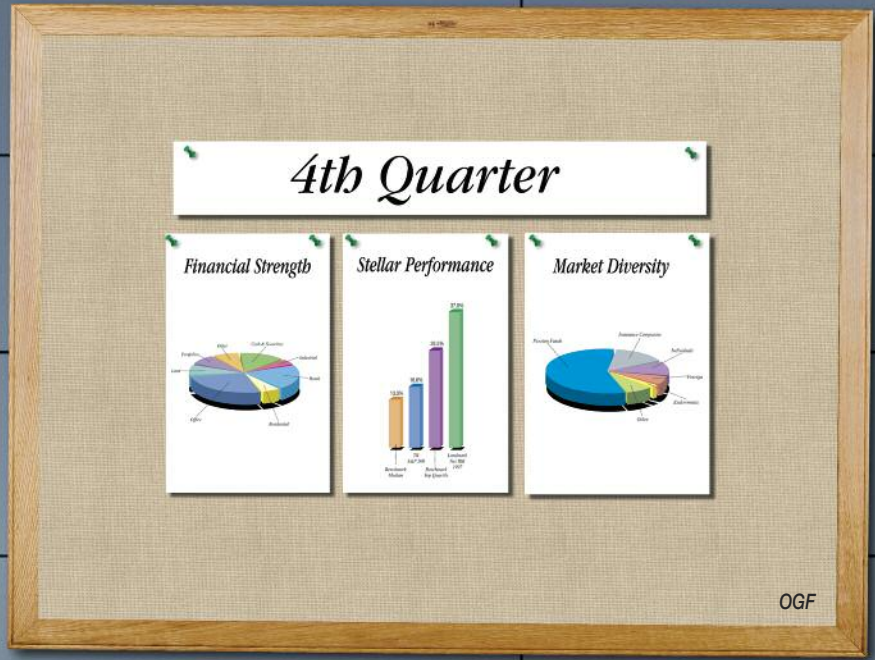

Oak wood trim oil finish with Guilford of Maine Bone #748 fabric

Fabric Tackboards

- Pick a fabric tackboard to accent your décor and add a splash of color; see page 34 for standard selection
- Guilford 701 Style 2100 is the most widely used fabric in offices and schools today
- Framed in 3/4" satin anodized aluminum trim or 1 3/4" white oak trim with an oil finish
- Concealed mounting hardware, screws included
- Class A fire-rated fabric on 1/2" thick Class C fire-rated bulletin board is standard

Options:

- Additional colors available from Guilford's 701-2100; a one-time color charge of \$60.00 per order, not per board
- Standard boards are Class A fire-rated fabric on 1/2" Class C fire-rated bulletin board. Please add \$1.50 per square foot for Class A fire-rated mineral fiber board core
- Red oak frame with a poly finish – add \$1.00 per linear foot of perimeter trim
- Satin or gloss maple trim – add \$3.50 per linear foot of perimeter trim
- Custom stains on standard white oak – add 20% or \$60.00, whichever is greater – see custom stains page 2
- Fabrics may be special ordered from any fabric company of your choosing for an additional charge
- Tackboards may be fabricated from customer supplied fabrics; call for details
- **Custom Sizes** – boards may be ordered in custom sizes or with minor alterations; take the price of the next largest size and add \$20.00 or 5%, whichever is greater

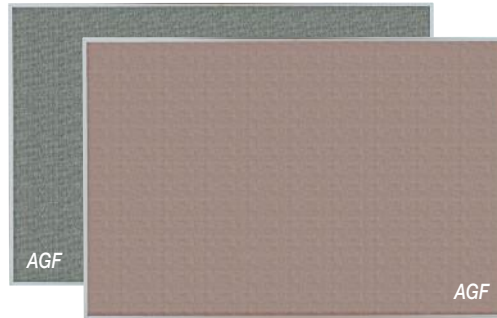

Aluminum trim with Guilford of Maine Grey Mix #238 fabric (above) and Cherry Neutral #400 fabric (below)



Guilford of Maine fabric adds a warm decorator detail to any room, see page 34 for color selection; #401 blue neutral pictured above



H x W (ft.)	Fabric Board Alum. Frame		Fabric Board Oak Frame	
	Fabric Board	List	Fabric Board	List
1 1/2 x 2	AGF1824	90.00	OGF1824	100.00
2 x 3	AGF23	116.00	OGF23	126.00
3 x 4	AGF34	190.00	OGF34	220.00
3 x 5	AGF35	241.00	OGF35	270.00
4 x 4	AGF44	260.00	OGF44	285.00
4 x 5	AGF45	320.00	OGF45	345.00
4 x 6	AGF46	357.00	OGF46	385.00
4 x 8	AGF48	460.00	OGF48	490.00
4 x 10	AGF410	570.00	OGF410	600.00
4 x 12	AGF412	620.00	OGF412	650.00

Aluminum 3/4" Trim

Wood 1 3/4" Trim

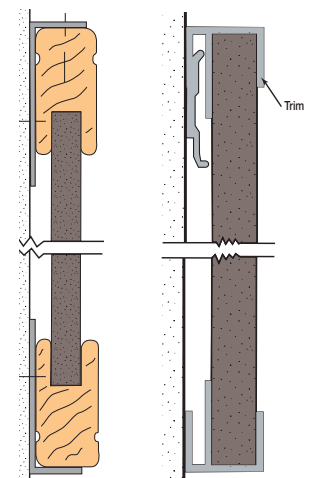

Wood oak frame detail

Aluminum frame detail



Porcelain Writing Surfaces

Lifetime Porcelain Writing Surfaces

These indestructible porcelain writing surfaces are warranted "for the life of the original installation." Guaranteed for a lifetime, these surfaces are:

- Fade resistant
- Easily erased
- Ultra smooth
- Accepts magnets
- Non-ghosting
- Chalk dust and residue reduced

Don't be fooled by claims of plastic films that stain, scratch, delaminate and are prone to air bubbles.

In 30+ years we have never had a failure of a porcelain surface.

Proven reliability – your customers deserve no less.

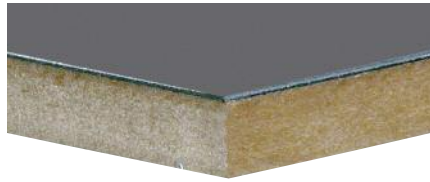

Porcelain on 1/2" Fiberboard

Sizes of porcelain on 1/2" low density fiberboard core – up to 4' x 12'. Standard core material for standard product line. Aluminum foil moisture barrier on back.

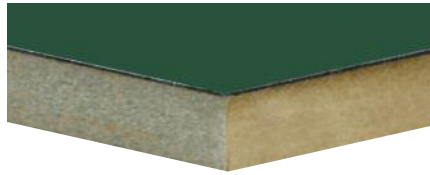

Porcelain on Particleboard (Architectural Series)

Sizes of porcelain on 7/16" particleboard core – up to 4' x 16' or 5' x 16'. Aluminum foil moisture barrier on back. Resists denting, more rigid and larger sizes available.



Extra Rigidity Option

For extra rigidity and resistance to warping from temperature swings and moisture variations, a heavy duty .015 aluminum backing sheet may be added to the back of any architecturally-spec'd marker or chalkboard.

Recover Or Replace Old Chalkboards



Recover or replace those old chalkboards. Call us and describe your situation so that we can correctly supply framed or unframed product that most economically meets your needs. Above: Old, hard to clean chalkboard; below: same wood trim with new porcelain markerboard and music staff markerboard (see page 13).



High Gloss Porcelain Markerboard

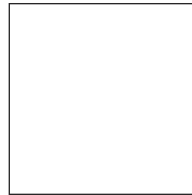

6100H - White



6101H - Light Gray

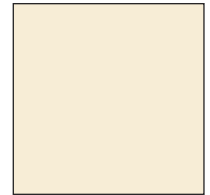

6102H - Beige

Low Gloss Porcelain Markerboard

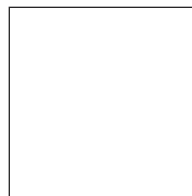

6100L - White



6101L - Light Gray

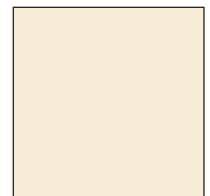

6102L - Beige

Ultra Matte Porcelain Chalkboard

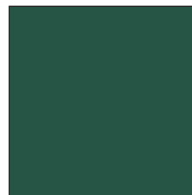

6500U - Green



6501U - Jet Black



6502U - Slate Gray

NOTE: If color is critical, call for a color swatch.



Permanent marker?

Wrong marker used? On porcelain, pigments stay on top of the surface and can be removed with water or markerboard cleaner.

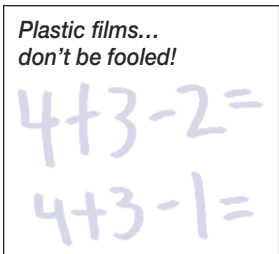

Plastic films... don't be fooled!

4+3-2=
4+3-1=

Tired of ghosted images on old markerboards? Porcelain won't ghost and improves erasability when used properly.





Wrapped Joint H-Bar (vinyl)

Architectural Tackboard Selection



1/8" Natural Cork on 3/8" Fiberboard
Economical – natural cork – push pins penetrate fully – sizes up to 4' x 12'.



1/4" Natural Cork on 1/4" Hardboard
Durable – rugged – sizes up to 4' x 16' and also up to 5' x 12' – No seams.

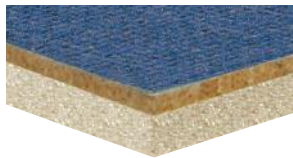

Koroseal Vinyl on 1/8" Natural Cork on 3/8" Fiberboard
Many colors, washable, push pins penetrate fully, sizes up to 4' x 12', larger sizes made with vinyl wrapped H-bar joint strips. Indigo vinyl pictured here, see page 2 for vinyl color chart.

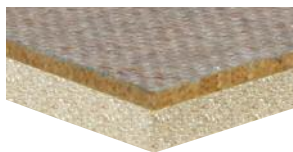

Guilford Fabric on 1/8" Natural Cork on 3/8" Fiberboard
Many colors, push pins penetrate fully, sizes up to 4' x 12', larger sizes made with fabric wrapped H-bar joint strips. Cherry neutral fabric pictured here, see page 34 for Guilford Fabric color chart.



Koroseal Vinyl on 1/2" Fiberboard
Economical, 18 oz. per linear yard, many colors, washable, push pins penetrate fully, sizes up to 4' x 12', larger sizes made with vinyl wrapped H-bar joint strips. Breakwater vinyl pictured here, see page 2 for color chart.

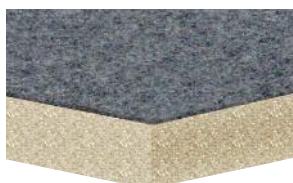

Guilford Fabric on 1/2" Fiberboard
Rich look of fabric, many colors, push pins penetrate fully, sizes up to 4' x 12', larger sizes made with fabric wrapped H-bar joint strips. Medium grey fabric pictured here, see page 2 for color chart.

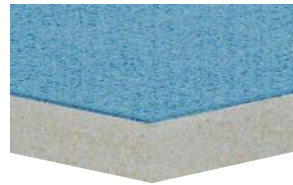

Koroseal Vinyl on 1/2" Class A Fire-rated Mineral Fiberboard

Completely non-combustible – meets most stringent fire codes for school hallways, college dorms, hospitals, nursing homes, washable, durable surface, 18 oz. per linear yard, sizes up to 4' x 12', larger sizes made with vinyl wrapped H-bar joint strips shown above, available in many colors. Tahoe vinyl pictured here, see page 2 for color chart.

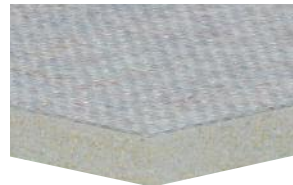

Guilford Fabric on 1/2" Class A Fire-rated Mineral Fiberboard

Many colors to choose from with the rich look of fabric. Completely non-combustible – meets most stringent fire codes for school hallways, college dorms, hospitals, nursing homes. Sizes up to 4' x 12' – larger sizes made with fabric wrapped H-bar joint strips. Blue neutral fabric pictured here, see page 34 for color chart.

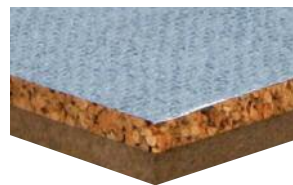

Koroseal Vinyl on 1/4" Cork on 1/4" Hardboard

Colorful, non-fading, non-staining, durable, 18 oz. per linear foot, up to 4' x 16'. Pacific vinyl pictured here, see page 2 for color chart.

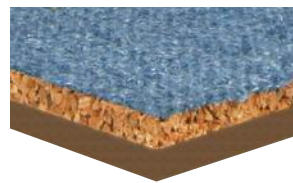

Guilford Fabric on 1/4" Cork on 1/4" Hardboard

Colorful, non-fading, sizes up to 4' x 16' and 5' x 12'. Larger sizes made with fabric wrapped H-bar joints. Wedgewood fabric pictured here, see page 34 for color chart.

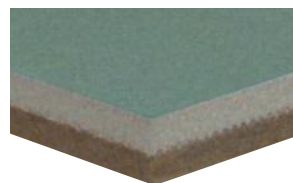

FORBO® Cork on 1/4" Hardboard

Most durable — 12 colors, washable, stain resistant, fade resistant, sizes up to 4' x 16', certain colors available up to 5' x 12', Class B fire-rated. 2203 FORBO® pictured here, see page 2 for color chart.



Deluxe Architectural Series Trim

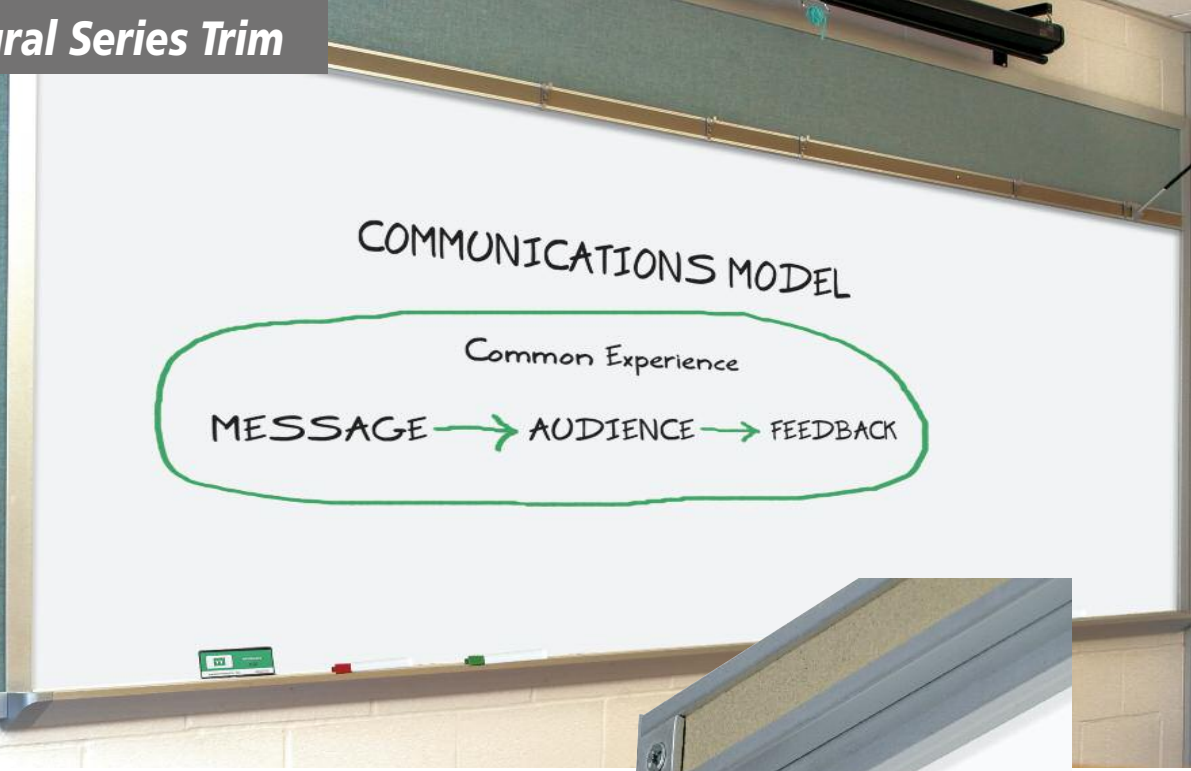

- **Deluxe trim 1½" wide x 7/8" thick.** All aluminum trim is satin anodized of not less than .062 wall thickness for extra rigidity.
- **Corners are mitered.**
- **Trays are box type hollow trays with endcaps.**
The 2¾" deep tray is satin anodized of not less than .080 wall thickness for additional strength.
- **Maprails are 1".**
- **Marker/chalkboard sizes** up to 4' x 16' and 5' x 16'; larger units available using concealed spline joints and color-matched H-bars.
- **Tackboard sizes** are made up to 4' x 12', 4' x 16' or 5' x 12', depending on the type of tackboard; see page 26.
- **Deluxe Series can be ordered as combinations** as illustrated below. Marker and chalkboard surfaces are joined with concealed spline joints. Joints between writing surface and tackboards are color matched H-bars to the writing surface.
- **Aluminum joints between vinyl or fabric tackboards** can be wrapped with the actual vinyl or fabric for a cleaner look.

Some of the combinations available:

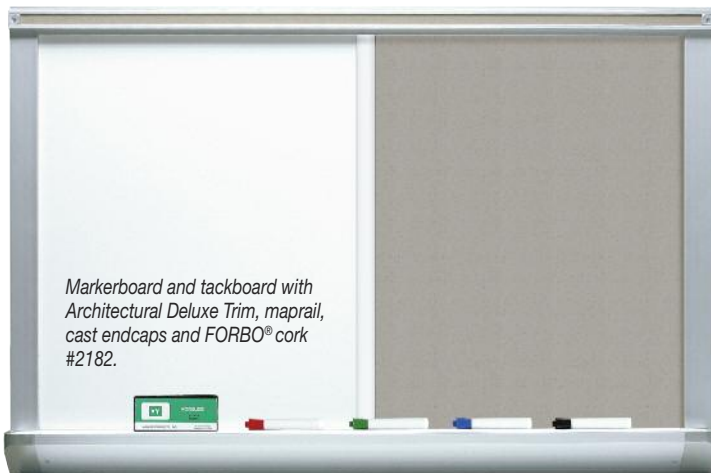

Deluxe trim 1" maprail



Box type tray with cast endcaps



H-bars are color matched to writing surface, shown with FORBO® #2166



Concealed spline joint provides nearly seamless transitions

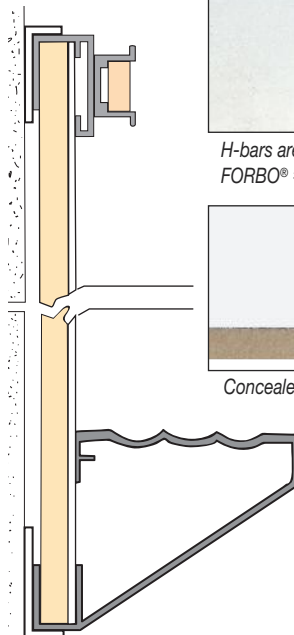

Marker or chalkboard detail with 1" maprail and box tray with cast endcaps



Standard Architectural Series Trim

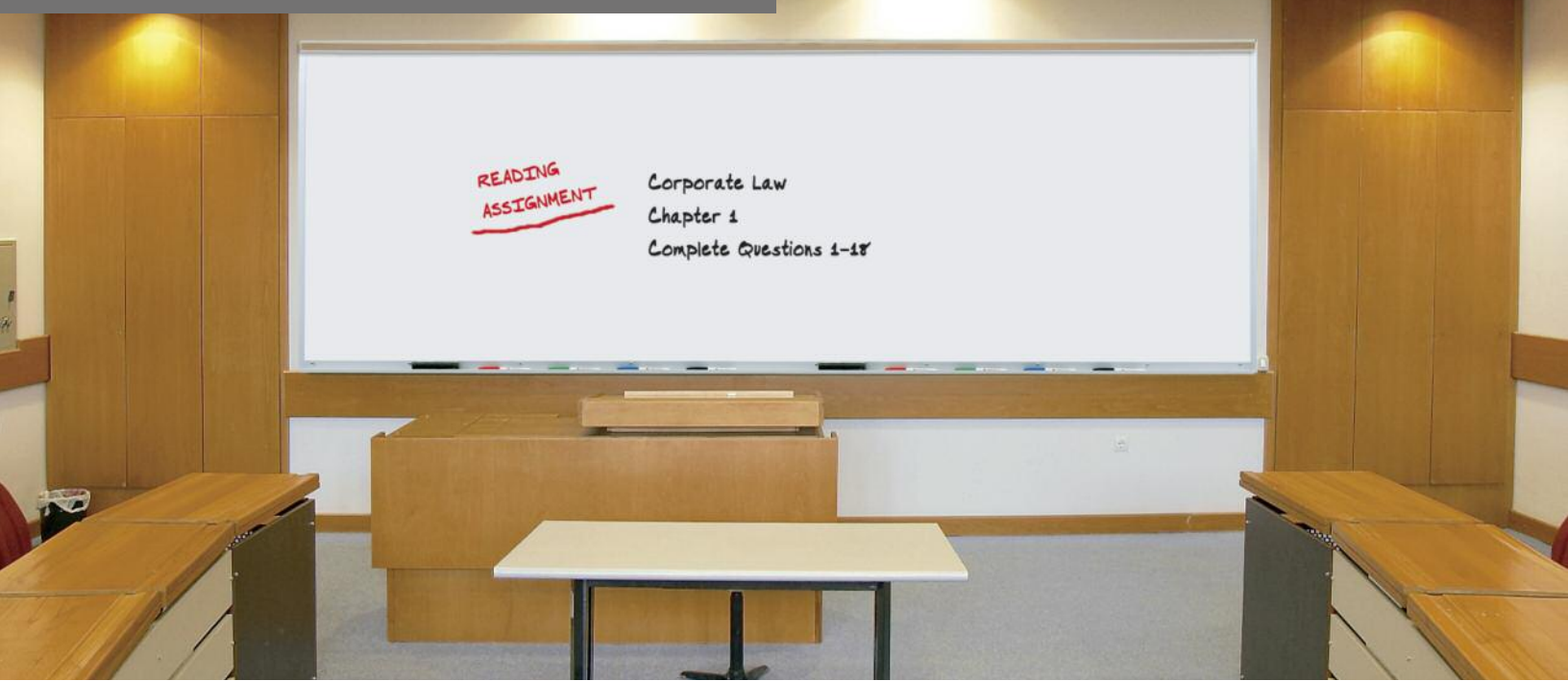

- **Aluminum trim is satin anodized** of not less than .062 wall thickness for added rigidity.
- **Trays are a minimum of .080 wall thickness** for added strength.
- **Corners are mitered.**
- **Trim is 3/4" wide and 5/8" thick.**
- **Standard architectural blade trays** are 2 1/2" deep.
- **Maprails** are 1" or 2" wide.
- **Optional tray** is a box type 2 3/4" deep hollow tray with cast endcaps.
- **Markerboard sizes** available up to 4' x 16' and 5' x 16' in one piece, larger units available made with concealed spline joints and color matching H-bars.
- **Tackboard sizes** available up to 4' x 12', 4' x 16' or 5' x 12' depending on the type of tackboard, see page 26; larger sizes available using H-bars.

Some of the combinations available:



Standard Architectural Series Details

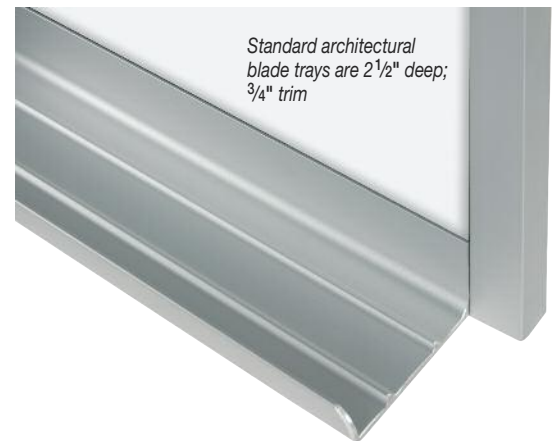
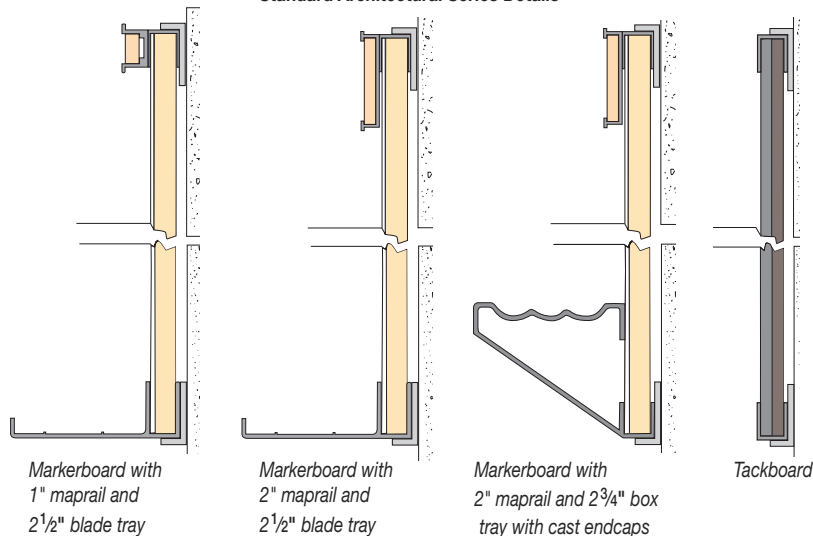

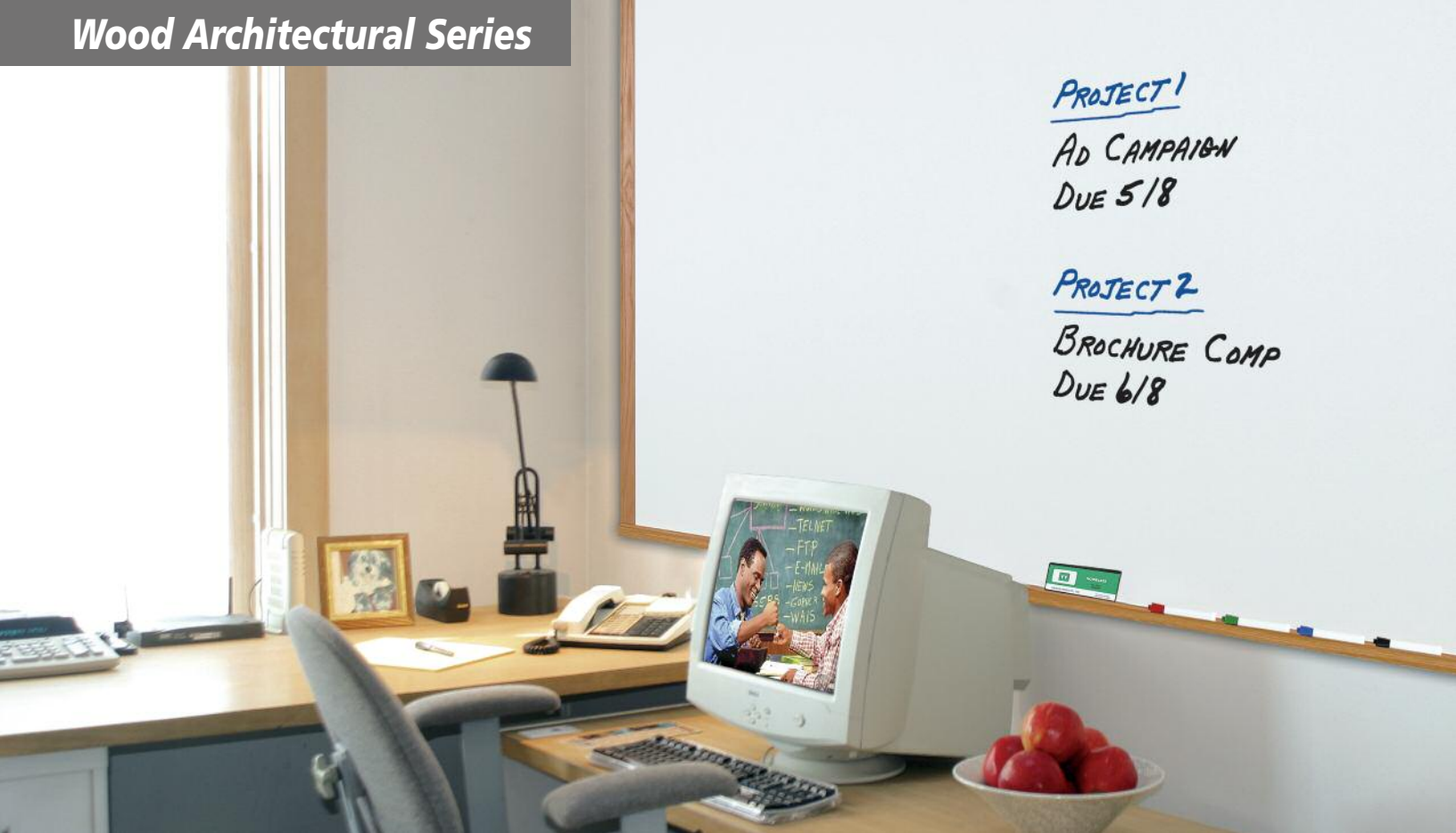

PROJECT 1
AD CAMPAIGN
DUE 5/8

PROJECT 2
BROCHURE COMP
DUE 6/8

- **Solid red oak** with a polyurethane finish.
- **Trim size** is 1 $\frac{3}{4}$ " wide x 1 $\frac{3}{16}$ " thick.
- **Tray size** is 1 $\frac{13}{16}$ " thick x 2 $\frac{1}{4}$ " deep.
- **Standard finishes** are gloss red oak, satin maple and gloss maple.
- **Marker/chalkboard sizes** available up to 4' x 16' and 5' x 16' in one piece, larger units available with concealed spline joints and color-matched H-bars.
- **Tackboard sizes** vary to a maximum of 4' x 12', 4' x 16' and 5' x 12' depending on the type of tackboard, see page 26; larger sizes available using color-matched H-bars.

Some of the combinations available:

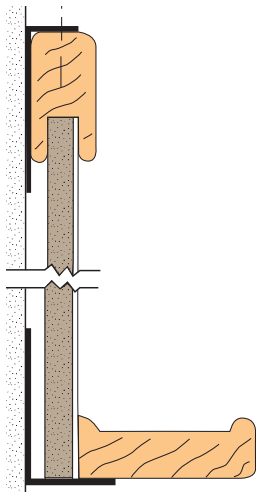

Detail wood markerboard with tray

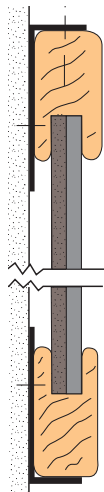

Detail wood tackboard



Satin maple wood trim with 1" maprail, FORBO® option #2187



Red oak gloss poly finish wood trim with tray



Satin Maple

Gloss Maple

Red Oak
Gloss Poly Finish



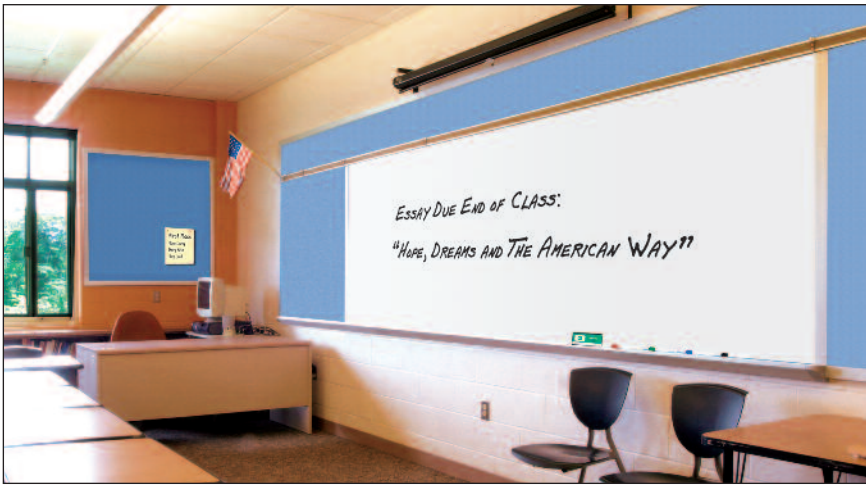

^ Before tackboard was changed

< After tackboard was changed

- **Snap-on trim is a field type installation** that requires a skilled installer to fabricate and install the trim, trays, maprail and mullions in the field. It allows for boards to be sized differently in each room to accommodate varying situations. Call us for the name of the installer nearest you.
- **Trim and maprail can be removed** at a later date in order to install a new tackboard panel or to change a chalkboard over to a markerboard.
- **The overall height of a snap-on installation** is 51" to 52". This is an ideal height when removing older installations that were taller than 48". When the old wood framed slate chalkboard is removed, the new installation will cover the old footprint which was left on the wall.



Snap-on system is infinitely changeable

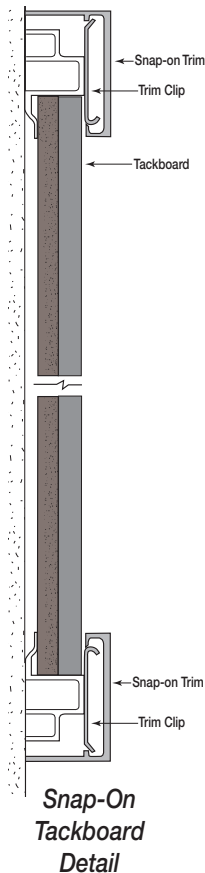
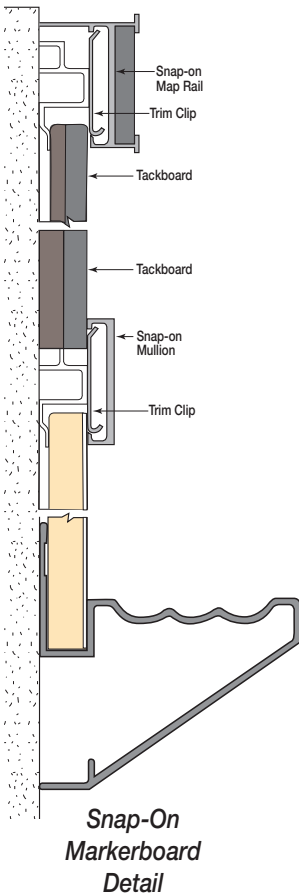



Fabric Tackboards Mounted on Walls, Floor-to-Ceiling, Over Lockers

Class A fire-rated fabric tackboards can be added to any hallway to brighten up those drab concrete and brick walls.

Tackboard edges can be wood or aluminum framed, fabric-wrapped or custom framed by the millwork.

Specify any fabric and our craftsmen will determine the best method to securely glue your specified fabric to the correct bulletin board material for your application.

Mount a tackboard over lockers to add a bulletin board and to quiet a noisy area.

All 1/2" thick tackboards should be permanently glued to the wall. All 3/4" and 1" thick tackboards can be mounted with Z-bars.

Options:

- Class A fire-rated tackboards may be made with our standard vinyl, see page 2; standard fabric see page 34, or any fabric of your choosing. See page 26 for additional types of fabric and vinyl tackboards
- Class A fire-rated backing is either 1/2" thick mineral fiberboard, available up to 4' x 12' or a 3/4" thick mineral fiberboard, available up to 4' x 8'
- Floor-to-ceiling fabric tackboards available



Neatly wrapped edges won't loosen or fray



Back side of panel is smoothly wrapped to lay flat on the wall



Neatly wrapped vinyl edge and corners



Neat fabric edges and corners



#1 SOURCE

Call Us...



The Walker Difference

Quality is designed and built into every Walker product. Our people are craftsmen who take pride in what they do. No excuses, no substitutions, no cut corners.

Custom work is our specialty. We have the experience, skilled craftsmen, materials, equipment and know-how that designers and architects have come to depend on for their custom projects.

We care about every order that we build. When you look good, we look good; it's that simple.

Communication is at the top of our list. Walker clients depend on us to listen to their needs and respond quickly with answers, prices and schedules they can count on. You won't be shuffled from one sales rep to another — you'll work directly with Steve Dee, our General Manager, who has worked at Walker since 1977.

Call us today and let us show you the Walker difference...



Custom work is our specialty.

We make the items our competitors can't make or don't want to. If someone says it can't be done, let us be your source. Call us today and we'll show you the Walker difference...

Special Pullout Color Reference

Back Cover: Fabric Selections

Front Cover: Wood, FORBO®, Vinyl Selections



WBT Chalkboard Porcelain: green 6500U



Walker Products Inc. 800 828.2096 www.walkerboard.com

32

Aluminum Extrusions

Walker Products stocks a wide range of aluminum extrusions to provide the best industry turnaround for our Advantage, Show Off, Headliner and Architectural Series. All extrusions are at 50% actual size.

MAPRAIL

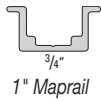

1" Maprail

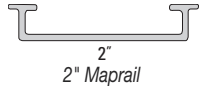

2" Maprail

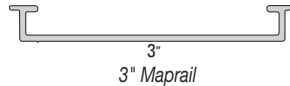

3" Maprail

TRIM

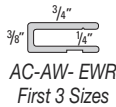

AC-AW- EWR
First 3 Sizes



AB-AV Style
Bulletin Board Trim



AC-AW- EWR First 3 Sizes

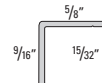

WAB Bulletin Board Trim



WAW Series Markerboard Trim

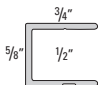

Standard Architectural Trim

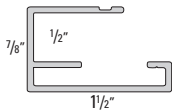

Deluxe Architectural Trim

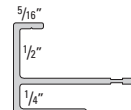

WRT-WBT Series

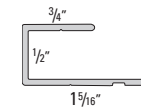

J Trim Field Use

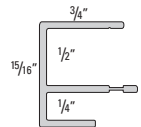

Standard EZ-Hang
WR-WB-WC Series

TRAYS

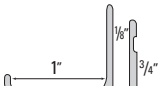

WAW Tray



AC-AW-EWR Tray
1st 3 Sizes

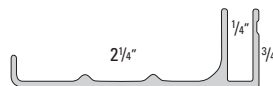

AC-AW Tray
Larger Sizes

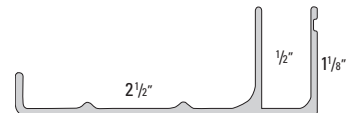

Standard Architectural Blade Tray

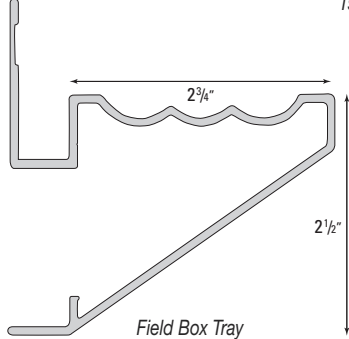

Field Box Tray

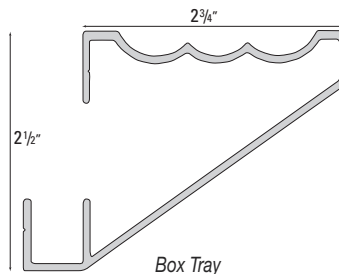

Box Tray

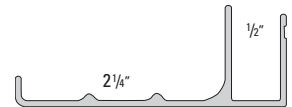

WR & WB Tray

SNAP-ON / H-BAR / Z-BAR

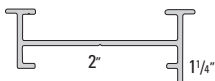

Snap-On Maprail

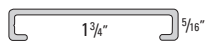

Snap-On Mullion

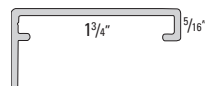

Snap-On Trim

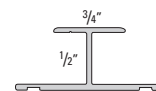

H-Bar

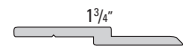

Z-Bar

FRAMES / TRACKS / DOOR TRIM

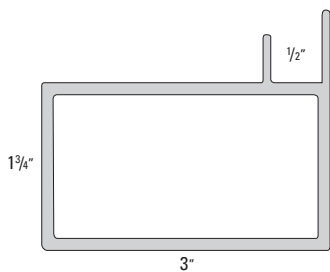

HSW-SBC Series Frames

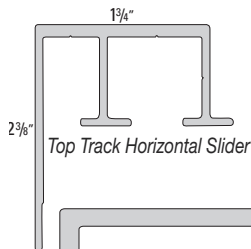

Top Track Horizontal Slider

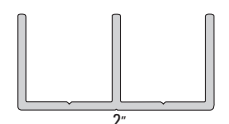

Bottom Track Horizontal Slider

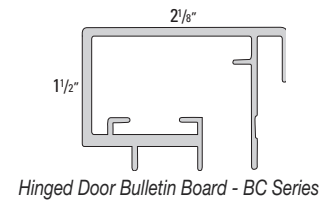

Hinged Door Bulletin Board - BC Series

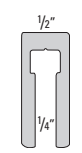

Door Trim
Hinged Case
BC Series



HSW Frame - Tube

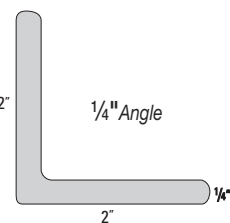

1/4" Angle



Guilford of Maine offers the most widely used fabrics in the office-furniture industry. Complement your existing fabric scheme with a custom fabric wrapped tackboard or wall.



Choose from a palette of designer fabric colors to bring added depth and richness to any tackboard program. These fabrics are Class A fire rated. Noise reduction can also be achieved when large wall areas are fabric covered.

15 stock colors are shown, 100% recycled polyester; additional fabric colors are available from Guilford of Maine style 701-2100 at \$60.00 per order.

Custom patterns can also be specified. The choice is yours! Call for quote.

NOTE: If color is critical, call for a color swatch.

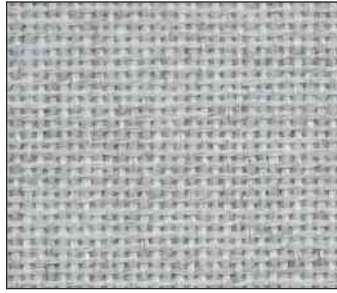

#538 Silver Papier



#380 Quartz

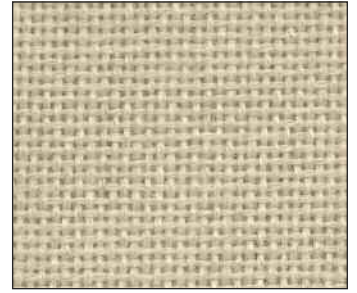

#748 Bone



#130 Wheat

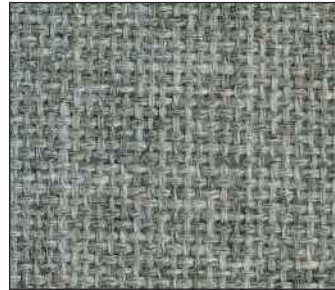

#238 Grey Mix



#298 Medium Grey

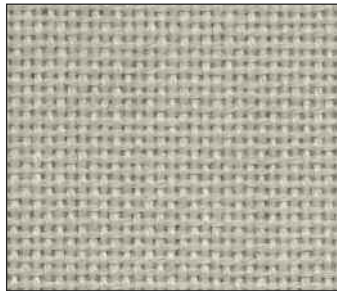

#481 Pearl



#400 Cherry Neutral

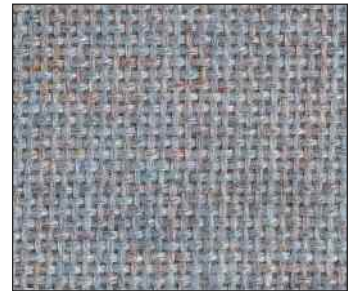

#401 Blue Neutral



#390 Rose Quartz



#539 Bleu Papier



#150 Wedgewood



#470 Ultramarine



#153 Baltic



#408 Black



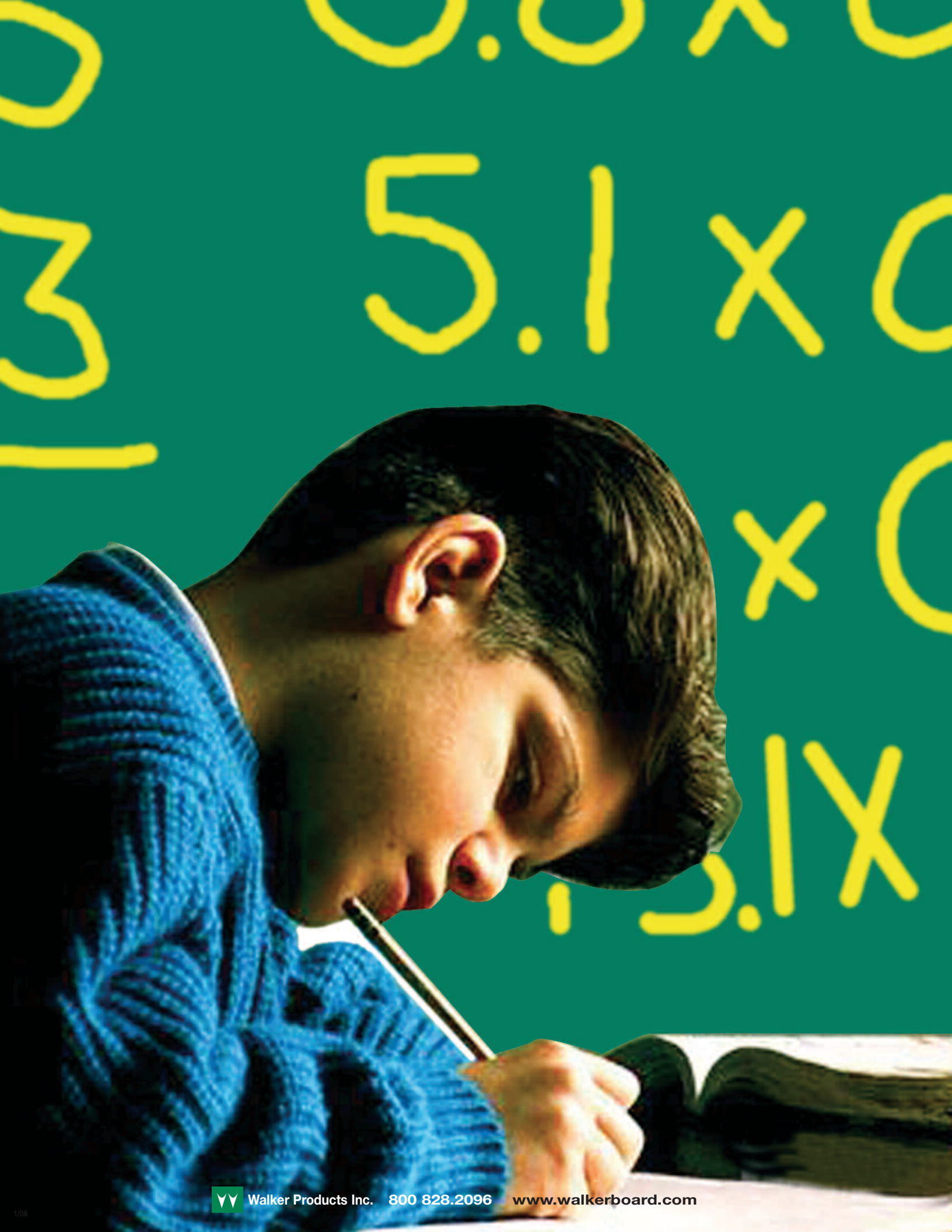

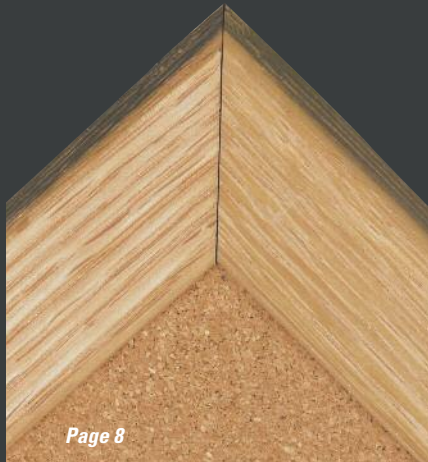

Page 8

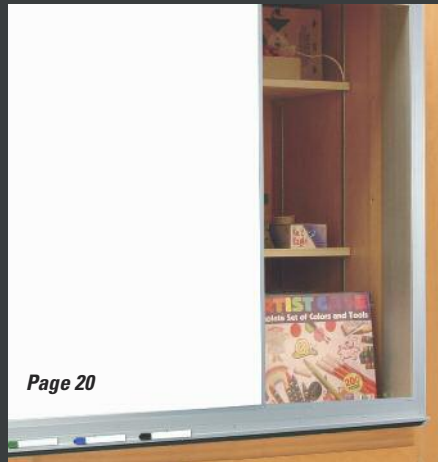

Page 20



Page 15



Page 17

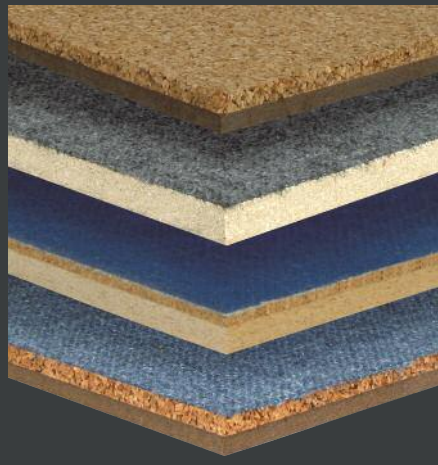

Page 26



Page 22

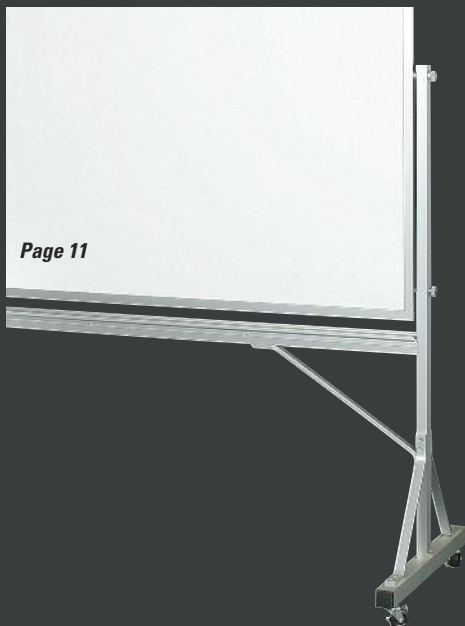

Page 11



Page 29



Page 27



WALKER

Products, Inc. **The Custom Board People**

Quality Custom & Stock Communication Boards Made in USA Since 1964

80 Commerce Street, Glastonbury, CT 06033

Phone: 800.828.2096 860.659.3781 Fax: 860.657.4809

www.walkerboard.com walkerproducts@aol.com

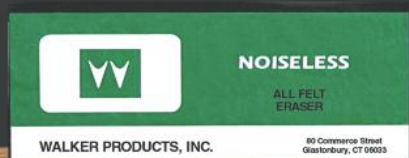

WALKER PRODUCTS, INC.

80 Commerce Street
Glastonbury, CT 06033