



PRODUCT COLLECTION  
Visual Communication Products

# STRIVING TO GIVE YOU **EXACTLY WHAT YOU WANT**

---

We're a family of companies with a single mission – delivering products and experiences that leave our customers with a feeling of “That’s Exactly What I Wanted!”

GMi Companies (Ghent, Waddell, and VividBoard) is headquartered in Lebanon, OH and proudly manufactures in the USA. Below are just a few of the ways we strive to go above and beyond for our customers. You can learn more about VividBoard on page 64 and Waddell on page 66.



## **MADE IN THE USA**

With over 95% of GMi products manufactured in the USA, you can have confidence in the quality, reliability, and availability every time. Custom options are always available.



## **DROP SHIP EXPERTS**

We've been drop-shipping directly to end-users and dealers for over 30 years. Whether it's one item or a truck load, we make it easy.



## **CUSTOMIZATION STANDARD**

Each order is produced on demand, just in time. That means we can customize products to your specifications.



## **ON-TIME DELIVERIES**

We are proud to claim the lowest freight damage in the industry, and we ship on time. Bottom line – we deliver on our promises, period.



## **QUALITY REPUTATION**

We take quality seriously at GMi Companies. Many Ghent products are warranted for 50 years. We stand behind our products.



## **EASY TO DO BUSINESS WITH**

Our goal is to make your life easier and hassle-free. From product information and quotes, to project management and easy invoicing, we are here for you.



# TABLE OF CONTENTS

## FEATURED PRODUCTS

<b>Aria</b> Glassboards .....	4
<b>Harmony</b> Glassboards .....	6
<b>LINK</b> Premium Powder Coated Whiteboards .....	8
<b>Roam</b> Mobile Whiteboards.....	12
<b>Nexus</b> Mobile Collaboration Furniture .....	14
<b>Simplicity</b> Next Generation Whiteboard .....	16
<b>Impression</b> Premium Wood Framed Whiteboards & Bulletin Boards .....	18

## GLASSBOARDS

Aria .....	22
Harmony .....	22

## WHITEBOARDS

Porcelain .....	26
Graphic Porcelain .....	28
Magnetic Steel.....	28
Non-Magnetic .....	29
Resurfacing Solutions.....	29
Accessories.....	30
Communication Furniture .....	32
Horizontal Sliders .....	32

## MOBILE WHITEBOARDS

Roam .....	36
Reversible .....	36
Nexus.....	38

## BULLETIN BOARDS

Premium Cork .....	44
Traditional Cork .....	44
Cintra .....	45
Recycled Rubber.....	45
Vinyl .....	46
Fabric.....	46
Colored Cork .....	47
Combination Boards .....	47

## ENCLOSED & LETTER BOARDS

Enclosed Bulletin.....	50
Designer Enclosed Boards.....	50
Traditional Enclosed Boards .....	50
Outdoor Enclosed.....	51
Customizable.....	52
Lighted.....	52
Letter Boards.....	53
Traditional .....	53
Customized .....	54
Pedestal.....	54













## EASELS & DISPLAY RAILS

Display Easels .....	58
Presentation Easels .....	58
Display Rails.....	59

## REFERENCES

Surface Guide .....	60
Finishes.....	61
VividBoard.....	64
Waddell.....	66

## ICON KEY

					
2 Business Day Shipping	10 Business Day Shipping	15 Business Day Shipping	Green	Accepts Magnets	Projection Surface
					
Product Warranty	TAA Compliant	ADA Compliant	Customizable	Lighted Option Available	Tackable Surfaces Available

# A R I A

## Low Profile Glassboards

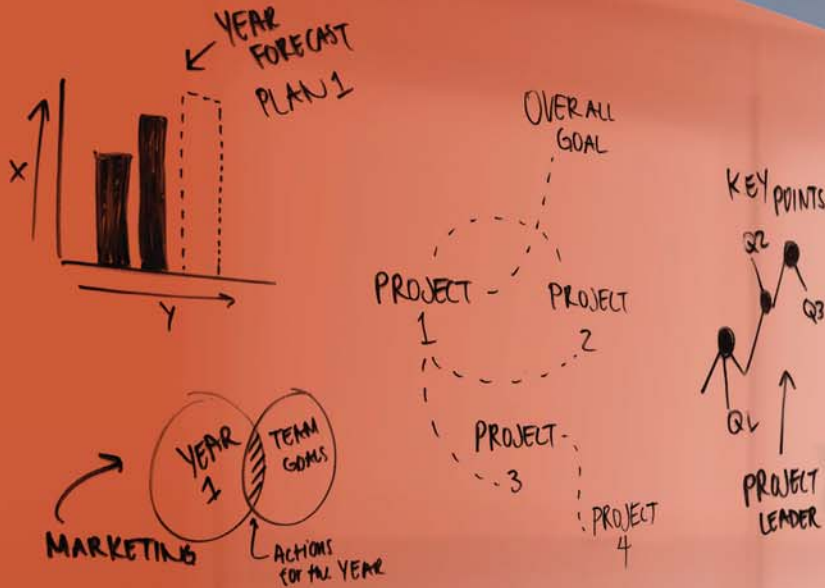

## The Most Secure Glassboard On The Market

**Most Secure** – heavy-duty hanging system gives confidence the board will never bow, strain, or move from the wall, creating a safe user experience.

**Low Profile** – 1/4" tempered glass floats only 1/2" from the wall surface, giving the illusion of floating glass.

**Integrated** – magnetic markers adhere under the glassboard allowing for a clutter-free writing surface.

**Limitless** – design your space by choosing to hang Aria vertically, horizontally, singular, or as a glass wall.

**Quality** – non-porous glass surface works with standard dry-erase markers and will not ghost or stain – guaranteed.

**Sustainable** – 100% recyclable; composed of recycled glass and sand.

4' x 8' Aria low profile glassboard shown in Peach.



## A Striking Composition Of Function Meeting Elegance

Aria low profile glassboards achieve the look of weightless, floating glass, creating a feeling of opulence from every angle. No visible hardware or standoffs allow the beauty of the glass to complement any décor. Our team of engineers developed a heavy-duty hanging system that promotes security and confidence that your board will never bow, strain, or move from the wall. With multiple orientation options, Aria can be used as a single board for personal offices and conference rooms, or designed as a glass wall, optimizing brainstorming and collaboration spaces.

Item No.	Description
<b>Non-Magnetic – Horizontal</b>	
ARIASN23XX	2' x 3' Low Profile 1/4" Glassboard – Horizontal
ARIASN34XX	3' x 4' Low Profile 1/4" Glassboard – Horizontal
ARIASN44XX	4' x 4' Low Profile 1/4" Glassboard – Horizontal
ARIASN45XX	4' x 5' Low Profile 1/4" Glassboard – Horizontal
ARIASN46XX	4' x 6' Low Profile 1/4" Glassboard – Horizontal
ARIASN48XX	4' x 8' Low Profile 1/4" Glassboard – Horizontal

Item No.	Description
<b>Non-Magnetic – Vertical</b>	
ARIASN32XX	3' x 2' Low Profile 1/4" Glassboard – Vertical
ARIASN43XX	4' x 3' Low Profile 1/4" Glassboard – Vertical
ARIASN44XX	4' x 4' Low Profile 1/4" Glassboard – Vertical
ARIASN54XX	5' x 4' Low Profile 1/4" Glassboard – Vertical
ARIASN64XX	6' x 4' Low Profile 1/4" Glassboard – Vertical
ARIASN84XX	8' x 4' Low Profile 1/4" Glassboard – Vertical

Item No.	Description
<b>Magnetic – Horizontal</b>	
ARIASM23XX	2' x 3' Magnetic Low Profile 1/4" Glassboard – Horizontal
ARIASM34XX	3' x 4' Magnetic Low Profile 1/4" Glassboard – Horizontal
ARIASM44XX	4' x 4' Magnetic Low Profile 1/4" Glassboard – Horizontal
ARIASM45XX	4' x 5' Magnetic Low Profile 1/4" Glassboard – Horizontal
ARIASM46XX	4' x 6' Magnetic Low Profile 1/4" Glassboard – Horizontal
ARIASM48XX	4' x 8' Magnetic Low Profile 1/4" Glassboard – Horizontal

Item No.	Description
<b>Magnetic – Vertical</b>	
ARIASM32XX	3' x 2' Magnetic Low Profile 1/4" Glassboard – Vertical
ARIASM43XX	4' x 3' Magnetic Low Profile 1/4" Glassboard – Vertical
ARIASM44XX	4' x 4' Magnetic Low Profile 1/4" Glassboard – Vertical
ARIASM54XX	5' x 4' Magnetic Low Profile 1/4" Glassboard – Vertical
ARIASM64XX	6' x 4' Magnetic Low Profile 1/4" Glassboard – Vertical
ARIASM84XX	8' x 4' Magnetic Low Profile 1/4" Glassboard – Vertical

XX = Replace with color code from swatches









i.e. **ARIASM23BK**

**ARIA** | **S** – Square Corners | **M** – Magnetic | **23** – Board Size (2' x 3') | **BK** – Black

i.e. **ARIASN34PH**

**ARIA** | **S** – Square Corners | **N** – Non-Magnetic | **34** – Board Size (3' x 4') | **PH** – Peach

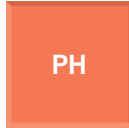
Each Aria glassboard includes (4) markers and (1) eraser.

 GY Gray	 YW Yellow	 BE Blue	 WH White
 GN Green	 BG Beige	 PH Peach	 BK Black*

**CUSTOM COLORS AVAILABLE**

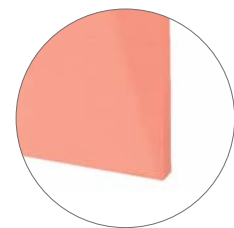

Square Corners

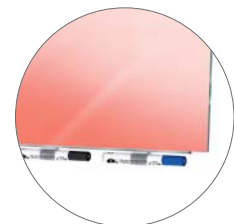

Integrated Marker Storage

Depending on lighting, angles, orientation, and wall color, glassboard appearance can vary.

\*Black glassboards require wet-erase markers, not dry-erase markers. Wet-erase markers are included with Black glassboard purchases.



# HARMONY

Glassboards with Standoffs



## Harmonize your thoughts

**Uncommon** – contemporary alternative to traditional whiteboards highlighted by the translucency and elegance of premium glass.

**Quality** – 1/4" thick, non-porous glass surface will not ghost or stain and works with standard dry-erase markers.

**Bold** – finishing touch of suspended mounting allows Harmony's beauty to be enhanced by ambient lighting.

**Green** – made from recycled glass and sand, and is 100% recyclable.

**Clever** – Harmony features our signature hidden marker-storage tray that is neatly tucked behind the glass.

4' x 6' Harmony glass shown in Blue.



# Brighten Your Brainstorm.

Harmonizing your thoughts has never looked so good. With eight colors (plus frosted) and five sizes to choose from, Harmony is a versatile and gorgeous way to brainstorm. Taking today's latest color trends and interior fashions into consideration, we've created the perfect palette of dry-erase boards to choose from. Change the way you think about a "whiteboard." Glassboards are the most premium writing surface we offer and guaranteed to never ghost or stain; one of the many reasons why we offer a 50-year warranty on Harmony Glassboards.

Item No.	Description
<b>Non-Magnetic</b>	
HMY__23XX	2' x 3' Non-Magnetic Harmony
HMY__34XX	3' x 4' Non-Magnetic Harmony
HMY__44XX	4' x 4' Non-Magnetic Harmony
HMY__45XX	4' x 5' Non-Magnetic Harmony
HMY__46XX	4' x 6' Non-Magnetic Harmony
HMY__48XX	4' x 8' Non-Magnetic Harmony

Item No.	Description
<b>Magnetic</b>	
HMY__23XX	2' x 3' Magnetic Harmony
HMY__34XX	3' x 4' Magnetic Harmony
HMY__44XX	4' x 4' Magnetic Harmony
HMY__45XX	4' x 5' Magnetic Harmony
HMY__46XX	4' x 6' Magnetic Harmony
HMY__48XX	4' x 8' Magnetic Harmony

**i.e. HMYRM23BK**

HMY – Harmony | R – Radius Corners | M – Magnetic | 23 – Board Size (2' x 3') | BK – Black

Each Harmony board includes hidden marker holder, (4) markers, and (1) eraser.

Depending on lighting, angles, orientation, and wall color, glassboard appearance can vary.

Black glassboards require wet-erase markers, not dry-erase markers. Wet-erase markers are included with Black glassboard purchases.

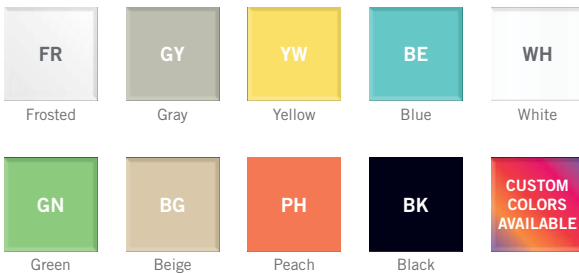

Radius



Square

**Custom Graphics and Logos also Available**  
**Call VividBoard at 877.543.2999**



# LINK

Premium Powder Coated Whiteboards

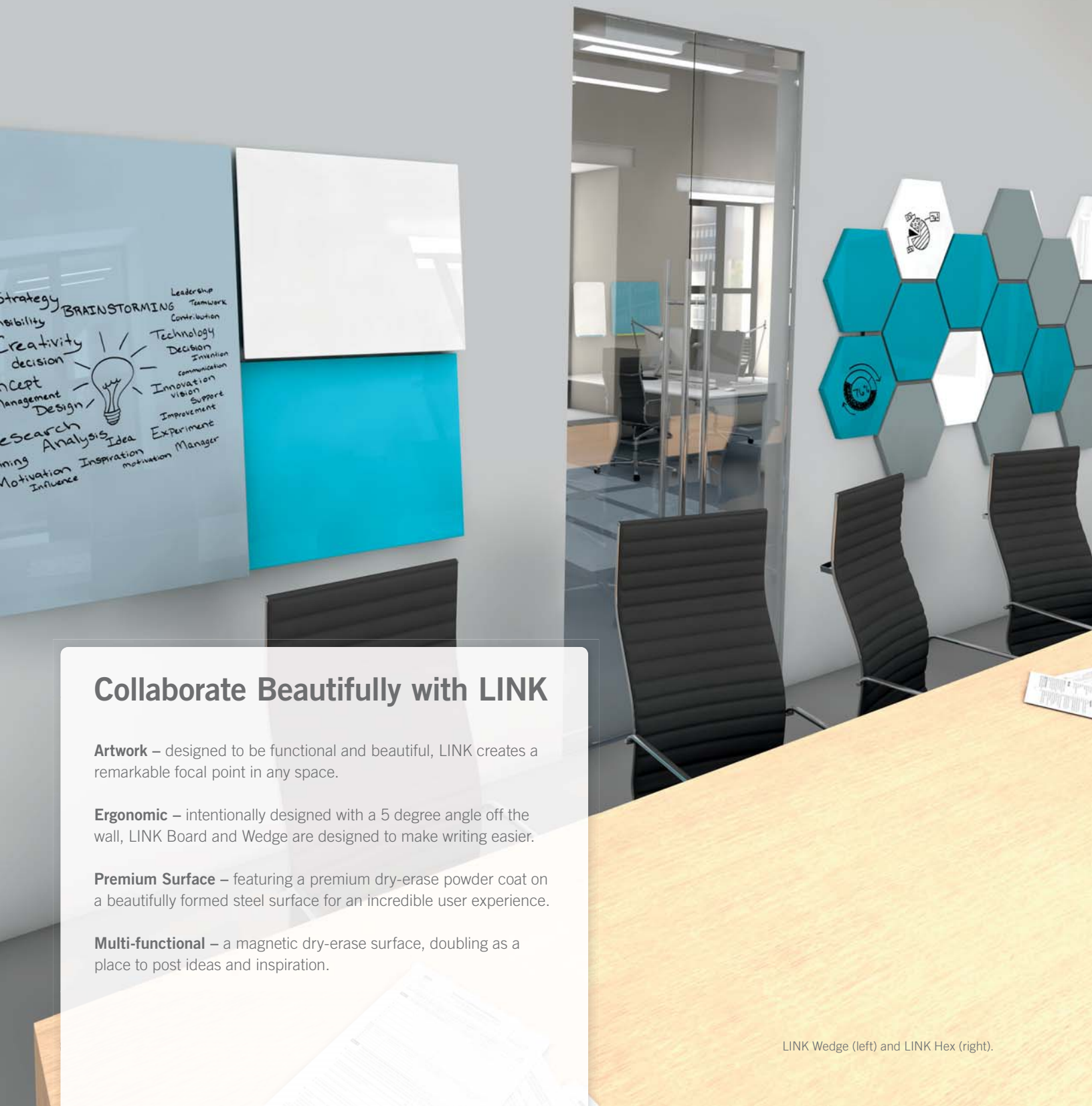

## Collaborate Beautifully with LINK

**Artwork** – designed to be functional and beautiful, LINK creates a remarkable focal point in any space.

**Ergonomic** – intentionally designed with a 5 degree angle off the wall, LINK Board and Wedge are designed to make writing easier.

**Premium Surface** – featuring a premium dry-erase powder coat on a beautifully formed steel surface for an incredible user experience.

**Multi-functional** – a magnetic dry-erase surface, doubling as a place to post ideas and inspiration.

LINK Wedge (left) and LINK Hex (right).





LINK Board, shown in various base and face colors.

# LINK BOARD

Personal spaces need personality. LINK Board was designed to add color, productivity, and mobility to modern workspaces. The removable board can be easily transported for use in group settings, while the base remains in place as an additional writing surface. LINK Board is available in three face and two base colors. Custom colors also available.

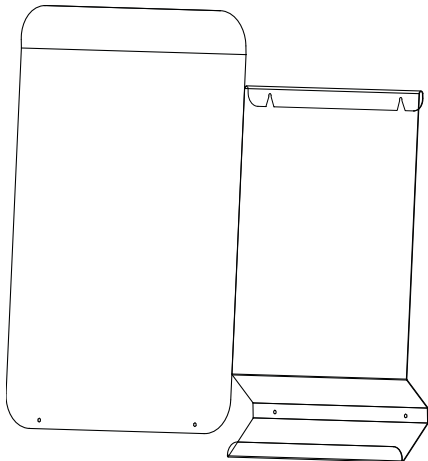

Item No.	Description	Face Color	Base Color
<b>24" x 18"</b>			
LWB2418BB	LINK Board 24" x 18"	Bright Blue	Soft Blue
LWB2418BG	LINK Board 24" x 18"	Gray	Soft Blue
LWB2418BW	LINK Board 24" x 18"	White	Soft Blue
LWB2418GB	LINK Board 24" x 18"	Bright Blue	Lime Green
LWB2418GG	LINK Board 24" x 18"	Gray	Lime Green
LWB2418GW	LINK Board 24" x 18"	White	Lime Green

<b>24" x 30"</b>			
LWB2430BB	LINK Board 24" x 30"	Bright Blue	Soft Blue
LWB2430BG	LINK Board 24" x 30"	Gray	Soft Blue
LWB2430BW	LINK Board 24" x 30"	White	Soft Blue
LWB2430GB	LINK Board 24" x 30"	Bright Blue	Lime Green
LWB2430GG	LINK Board 24" x 30"	Gray	Lime Green
LWB2430GW	LINK Board 24" x 30"	White	Lime Green

Each LINK Board comes with magnetic accessories, (1) marker, (1) microfiber cloth, to allow for ultimate flexibility.



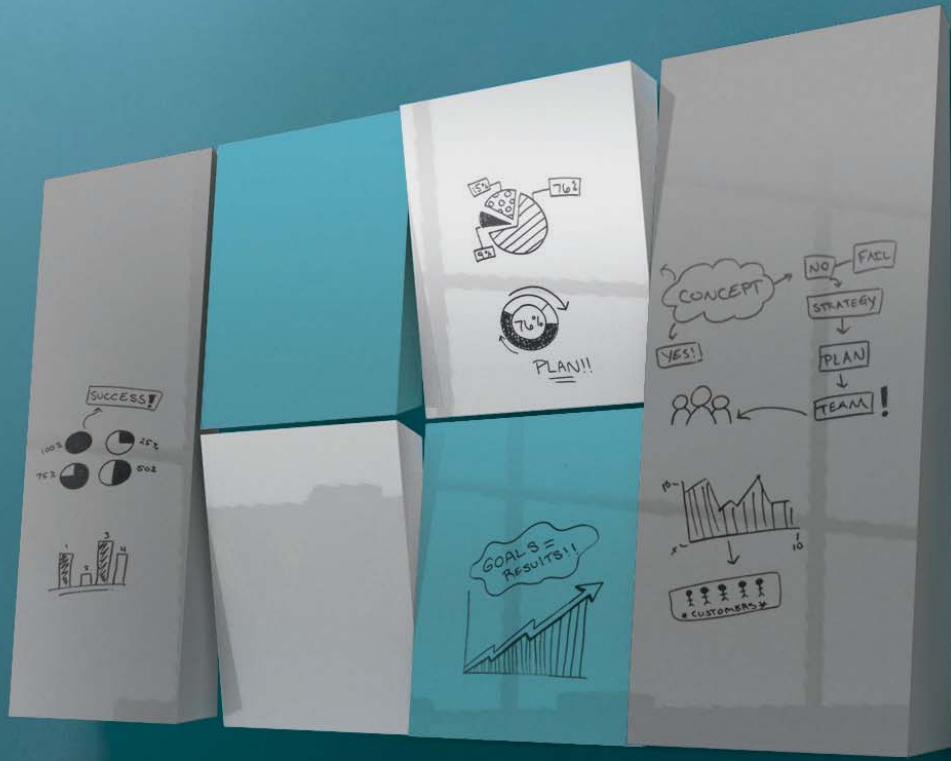

LINK Wedge shown in various size and color options.

# LINK WEDGE

Conference rooms don't have to be boring anymore with LINK Wedge. Designed specifically to be magnetic, ergonomic and configurable, LINK Wedge takes your dry erase board to the next level. The simple track-hanging system makes it easy to configure a design all on your own. Get creative with the layout by using the small and large sizes next to each other to create dynamic and functional artwork. Available in two sizes and three standard colors. Custom colors also available.

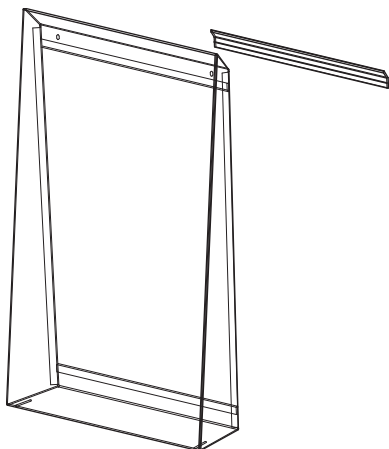

Item No.	Description	Wedge Color
<b>Half Size 24" x 30"</b>		
LW2430BB	LINK Wedge 24" x 30"	Bright Blue
LW2430GY	LINK Wedge 24" x 30"	Gray
LW2430WH	LINK Wedge 24" x 30"	White
<b>Full Size 48" x 30"</b>		
LW4830BB	LINK Wedge 48" x 30"	Bright Blue
LW4830GY	LINK Wedge 48" x 30"	Gray
LW4830WH	LINK Wedge 48" x 30"	White

Each LINK Wedge comes with magnetic accessories to allow for ultimate flexibility, (1) marker, and (1) microfiber cloth.





LINK Hex shown in various color options.

# LINK HEX

When was the last time a whiteboard had some attitude? LINK Hex was designed to make public or private spaces more personal with configurable hexagonal magnetic whiteboards. Take a simple Hex and create a canvas to suit your needs. LINK Hex will make your common areas uncommon; lobbies become conversation centers and hallways become brainstorming-central. Available in three standard colors. Custom colors also available.

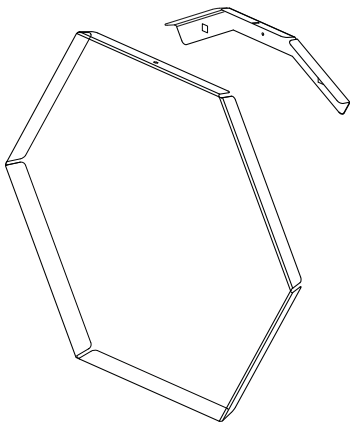

Item No.	Description	Hex Color
<b>16.2" x 19.7"</b>		
LH16201BB	LINK Hex – 16.2" x 19.7"	Bright Blue
LH16201GY	LINK Hex – 16.2" x 19.7"	Gray
LH16201WH	LINK Hex – 16.2" x 19.7"	White

Each LINK Hex comes with a magnetic marker for ultimate flexibility.

Product is shipped with an easy "How-To" installation guide that can also be found by visiting [ghent.com/hex](http://ghent.com/hex).

(1) magnetic marker included, (1) microfiber cloth optional.



# R O A M

## Mobile Whiteboards

### Roaming in Concert with You

**Functional** – designed to be a simple product that embodies form and function.

**Compact** – the compact nesting feature allows multiple products to be used and stored in one footprint, maximizing space.

**Mobile** – heavy-duty casters allow for ease of use across multiple flooring surfaces, roaming easily throughout collaboration sessions.

**All-in-one** – the double-sided, edge-to-edge writing surface and accessory tray, allow multiple ideas to be shared in one common place.

**Stability** – Roam's low center of gravity creates stability for a steady writing surface and allows for ease of use when rolling to and from locations.



# Why Stand Still When You Can Roam?

You shouldn't have to stand still to collaborate... Roam, a mobile whiteboard, allows for on-the-go collaboration. Designed to be simple and clean, Roam is a prime example of form meeting function. Line up multiple Roam whiteboards to create a larger dry erase surface for use during presentations; or move them around the room for breakout sessions. When at rest, the unique nesting feature allows multiple units to fit within a single footprint, maximizing your valuable space. You shouldn't have to be stationary during collaboration and brainstorming. Go ahead... Roam.

- Double-sided mobile whiteboard with edge-to-edge writing surface
- 36" x 42" writing surface constructed of non-ghosting, high pressure laminate
- Satin aluminum double-sided tray and legs complement any décor
- Constructed with 2.5" heavy-duty casters that allow for ease of use throughout any flooring surface
- Compact nesting allows for multiple units to fit within the same footprint
- Low center of gravity creates stability in use and while roaming
- Optimal for seated or standing positions
- Lightweight – complete unit only weighs 24 lbs, overall dimensions are 36" x 68.5"
- Backed by Ghent's 10-year warranty



Item No.	Description
<b>Non-Magnetic</b>	
RM36SAWHN	Roam Mobile, 36" x 68.5" Satin aluminum base, whiteboard

Each Roam includes (4) markers and (1) eraser.



# NEXUS

## Mobile Collaboration Furniture



### Promote Freer Thinking

**Collaborative** – create a culture that supports collaboration, allowing you to share and build knowledge while empowering individuals within the small group dynamic.

**Mobile** – organizations can put a whiteboard at their employees' fingertips virtually anywhere they choose to work. It moves where you move. It works where you work.

**Intuitive** – the Nexus family of products interact with each other, contributing to open discussions and communications in a team environment.

**Modern design for the modern office** – designed to work in open office spaces where there are no fixed walls for traditional whiteboards, but people still need to collaborate.

**Flexible** – mobile double-sided magnetic whiteboards allow the user to configure their work space as needed without a permanent structure.



## Focus the Conversation

Item No.	Description	Size
NEX201TC	Nexus Caddy	72.25" x 32.5" x 25"
NEX106TM	Tablet	27.875" x 27.875" x .75"
NEX203ME	Easel	76" x 40.375" x 25"
NEX206MW	IdeaWall	6" x 76.375" x 25"
NEX021XHL	X-Hangers	Fits Partitions 1.5" to 3.5" thick
NEX006XP	X-Pegs	.75" x 1"
NEX134WMB	Wall Board	36" x 48" and 48" x 72"
NEX204EP	Easel+	76" x 41" x 25"
NEX224MMP	Partition	76" x 53" x 25"
NEX223MP	Jr. Partition	58" x 34" x 25"



“You cannot really appreciate the power and magic of Nexus until you use it. It’s not just one thing; it’s everything about it. The two distinct surface areas help separate

ideas or discussion topics, whether it be strategic and tactical, or visuals and task lists. I call the tablet my ‘laptop’ — I can sit down with a client and collaborate or share a concept together, then hang it up and use it as a reference when we work on the adjoining big board. All I can say is that this system just flat-out invites collaboration and engagement like no traditional whiteboard or flip chart ever could.”

– Paul Heagen, Founder & Executive Coach  
**DEFINING Moments™**

Custom Graphics, Colors, and Logos Available  
Call VividBoard at 877.543.2999

# SIMPLICITY

Next Generation Whiteboard

INFUSED WITH  
**ACRYLITE®**

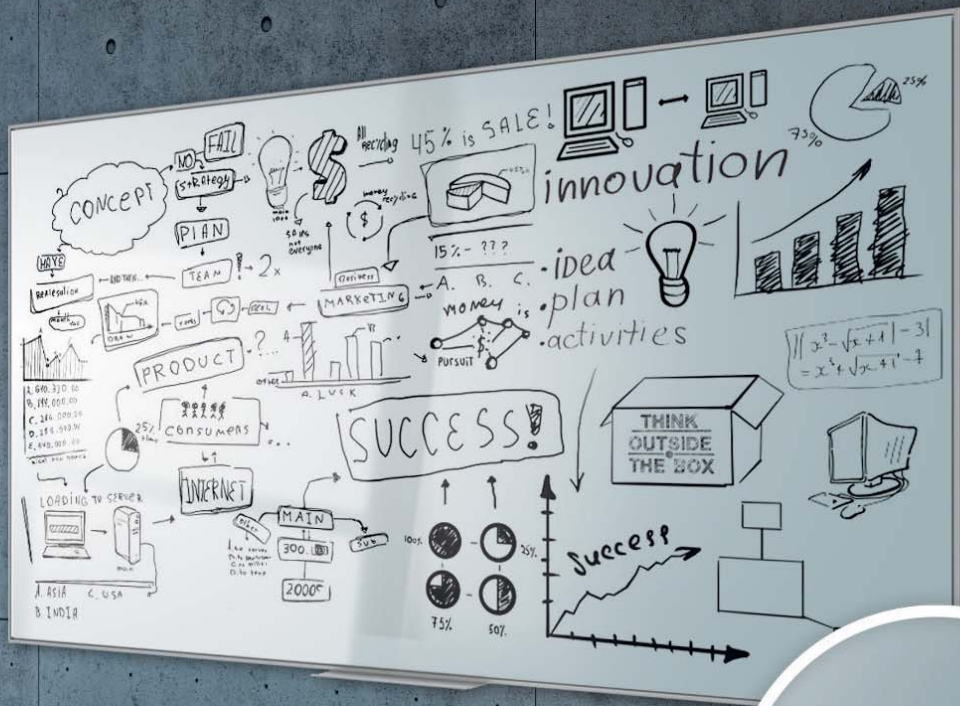

## Keep it Simple

**Elegant** – designed to co-exist in the world of future systems and communication tools, the clean lines of Simplicity de-emphasize the impact of the frame, giving the board a virtually frameless feel.

**Innovative** – by incorporating a material never before used in a commercial whiteboard, Simplicity becomes a one-of-a-kind communication tool.

**Durable** – the patented Acrylite® surface has twice the scratch resistance of glass, but only half the weight. This means a more dependable board that is easier to handle.

**Mountable** – our invisible mounting system uses a z-bar hanging bracket to ensure a level hang with minimal work.

4' x 6' Simplicity whiteboard.





## Let Your Ideas Float Freely.

Simplicity was designed to take the busyness out of your whiteboard. With big, bulky frames and obstructed views, traditional whiteboards aren't designed for modern spaces. Enter Simplicity. The seamless lines and shadow-reveal are intentionally crafted to make the ordinary, extraordinary. Couple these features with a next-generation Acrylite® (guaranteed to not ghost or stain for 50 years) writing surface, and Simplicity becomes a one-of-a-kind communication tool.

Item No.	Description
<b>Non-Magnetic</b>	
SI023A	2' x 3' Simplicity
SI034A	3' x 4' Simplicity
SI044A	4' x 4' Simplicity
SI045A	4' x 5' Simplicity
SI046A	4' x 6' Simplicity
SI048A	4' x 8' Simplicity
<b>Magnetic</b>	
SI023AM	2' x 3' Magnetic Simplicity
SI034AM	3' x 4' Magnetic Simplicity
SI044AM	4' x 4' Magnetic Simplicity
SI045AM	4' x 5' Magnetic Simplicity
SI046AM	4' x 6' Magnetic Simplicity
SI048AM	4' x 8' Magnetic Simplicity

Accessories Included: (4) markers, (1) eraser, and (1) attachable aluminum tray  
 Optional Accessories: Marker basket (pictured above)

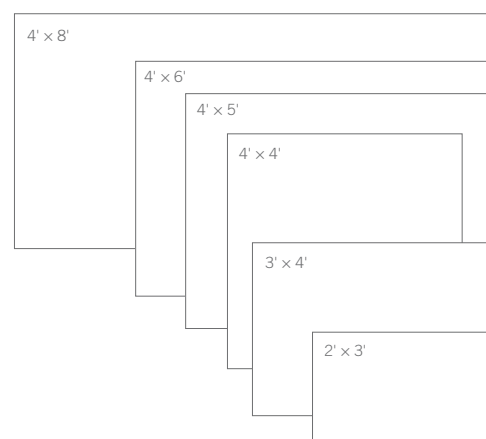

# I M P R E S S I O N

Premium Wood Framed Whiteboards & Bulletin Boards



## Communicate in Style

**Stylish** – premium frames, functional surface options, and our hidden marker storage creates a polished and clean appearance.

**Robust** – Impression whiteboard surface is 28 gauge porcelain-on-steel for a superior writing experience.

**Versatile** – various wood framing and tackable fabric options allow you the flexibility to customize your dry erase or bulletin board for your space.

**Timeless** – classic and modern framing options allow your board to encompass any design style.

3' x 4' Impression Whiteboard (left) and Bulletin Board (right) both shown in Cherry Modern frame.



# Make a Lasting Impression.

When the things you communicate need to make a statement, Impression is the perfect choice. Impression whiteboards and bulletin boards are framed with premium wood and are available in an array of finishes and surfaces. Impression is designed for you to communicate beautifully.

Item No.	Description
<b>Whiteboards</b>	
IM_23W__	2' x 3' Impression Porcelain Whiteboard
IM_34W__	3' x 4' Impression Porcelain Whiteboard
IM_44W__	4' x 4' Impression Porcelain Whiteboard
IM_45W__	4' x 5' Impression Porcelain Whiteboard
IM_46W__	4' x 6' Impression Porcelain Whiteboard
IM_48W__	4' x 8' Impression Porcelain Whiteboard

Item No.	Description
<b>Bulletin Boards</b>	
IM_23_F__	2' x 3' Impression Fabric Bulletin Board
IM_34_F__	3' x 4' Impression Fabric Bulletin Board
IM_44_F__	4' x 4' Impression Fabric Bulletin Board
IM_45_F__	4' x 5' Impression Fabric Bulletin Board
IM_46_F__	4' x 6' Impression Fabric Bulletin Board
IM_48_F__	4' x 8' Impression Fabric Bulletin Board

i.e. **IMM23WCH**  
**M** – Modern Style | **23** – Board Size (2 x 3) | **W** – Whiteboard | **CH** – Frame Color  
 i.e. **IMC23CHF90**  
**C** – Classic Style | **23** – Board Size (2 x 3) | **CH** – Frame Color | **F** – Fabric | **90** – Fabric Color



Modern Frame



Classic Frame

### Frame Finishes

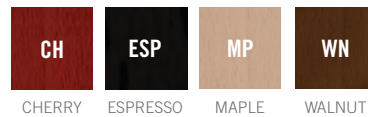

CH CHERRY | ESP ESPRESSO | MP MAPLE | WN WALNUT

### Fabric Options

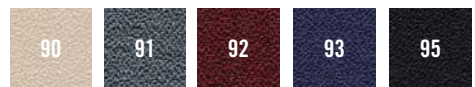

90 BEIGE | 91 GRAY | 92 MERLOT | 93 BLUE | 95 BLACK

For more fabric and finish options, visit [www.ghent.com/finishes](http://www.ghent.com/finishes)



1. Bulletin boards 2. Whiteboards

# GLASSBOARDS

Premium Dry-Erase Glassboards

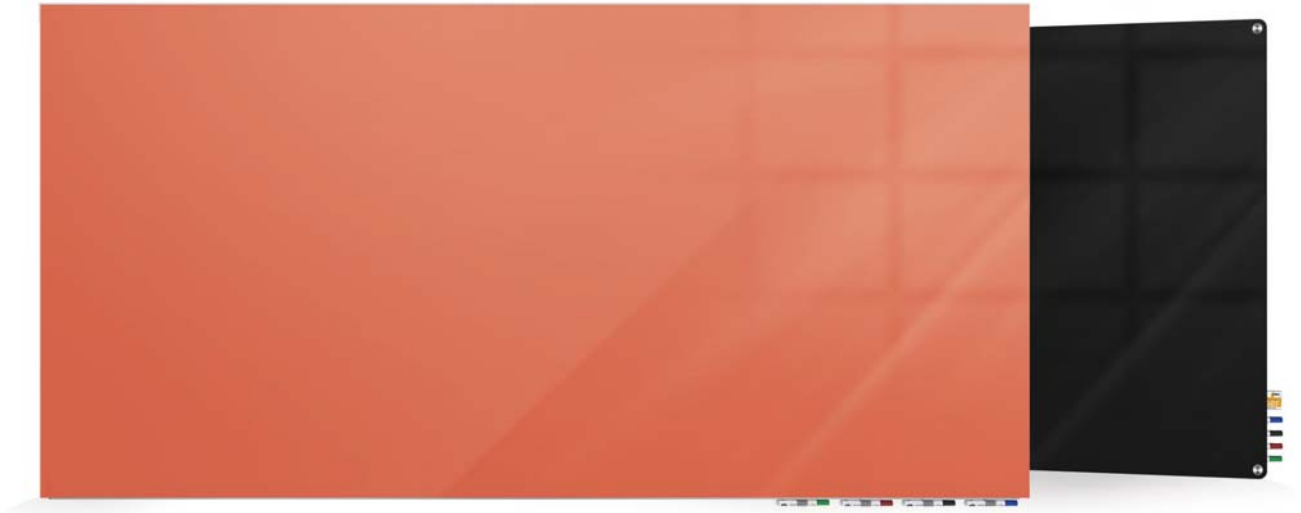

**Creativity begins  
with color**

Modernize your space with glassboards and dry-erase boards from Ghent. Available in non-magnetic or magnetic, with or without exposed hardware, and in a variety of color options to match any environment.



Three 4' x 8' Aria low profile glassboards shown in Blue.

## ARIA

### Aria (ARIA)

Low profile glassboards with no exposed hardware.

- 1/4" tempered low profile glassboard floats only 1/2" from the wall surface
- Installed with heavy-duty aluminum cleating and a steel support bar that work together to safely secure the glassboard to the wall
- One-of-a-kind hanging process allows Aria to be mounted to any surface, including uneven surfaces like brick or concrete
- Integrated underneath marker storage allows for an uncluttered writing surface
- Concealed hardware creates a clean, frameless, and superior dry-erase surface
- Available in square edges, magnetic, or non-magnetic
- Choose from eight standard colors; custom colors also available
- Unlimited design options—hang vertically or horizontally, as a single board, or build a glass wall by joining multiple boards side by side
- Backed by Ghent's 50-year warranty

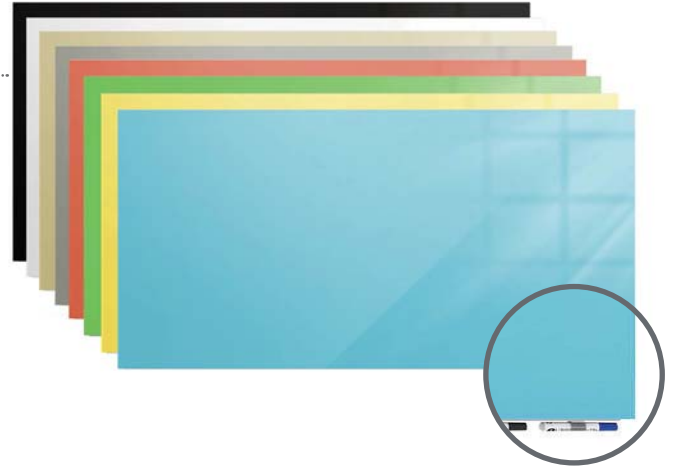

## HARMONY

### Harmony (HAR)

Premium glassboards with stand-offs.

- Tempered 1/4" thick glass with rounded or squared corners
- Pre-drilled mounting holes are inset into the glass: four holes for the 2' x 3', 3' x 4', and 4' x 4', and six holes for the 4' x 5', 4' x 6', and 4' x 8'
- 1" diameter satin aluminum standoff hangers create 1/4" spacing between wall and glassboard
- Features a unique, clear acrylic, rear-mounted accessory holder, complete with markers and eraser
- Backed by Ghent's 50-year warranty
- Magnetic version includes four rare earth magnets (extra magnets available)
- Available with custom colors, graphic, and logo printing





4' x 6' Harmony glassboards shown in yellow.

# WHITEBOARDS

Communicate. Collaborate. Learn.



“  
**Collaboration starts  
 with an idea, a dream**

People need to communicate, collaborate, and learn whether they're in schools, board rooms, hospitals or at home. Our whiteboards are offered in an array of surfaces and frames to allow people to communicate, collaborate, and learn in the style and fashion they prefer.

**Need help choosing the write surface?**

Visit page 60 or check out [www.ghent.com/writesurface](http://www.ghent.com/writesurface) to learn what makes our surfaces unique and choose the best solution for your needs.



# How to Move Rankings Up On Older, Existing Content

## Air Conditioners

- ① Competitor X  
url
- ② Competitor Y  
url
- ③ Competitor Z  
url
- ④ Your A/C Page  
url



## ④ Internal links + redirects

- Make sure the page is getting love from all the relevant URLs
- Consolidate! If you have lots of pages targeting the same term/phrase, consider 301'ing all to one place

## ① Point more external links to your existing URL

- Tough w/ commercial content, but easier w/ educational or non-promotional stuff
- Guest content, promotions, partnerships, testimonials/reviews, list inclusion, press/blog, social media pushes, and link reclamation have, in my experience, worked best.
- Be really careful not to build the wrong links

## ② Increase your click-through rate

- Supplement with PPC ads →  $111=2.25$
- Test modifications to title/description
- Add rich snippet data (Author/images/reviews/video)

## ③ Improve/re-vitalize on-page content

- Rich media - video, images, graphics
- Layout, design, UX, visual aesthetics
- Text content - not keywords, but unique VALUE!

## ⑤ Branding, Co-occurrence, + Mentions

## Typical Infographic



! <embed me >!

## PORCELAIN WHITEBOARDS

### Magnetic Porcelain (M1 & M1W)

Traditional porcelain whiteboards with detachable marker tray.

- Heavy-duty porcelain-on-steel surface on a 3/8" backing
- Available in either a satin aluminum or a solid oak, natural finish
- Durable surface accepts magnets and resists scratches and stains
- Detached SmartPak blade-tray for easier installation and reduced potential for damage
- Available in 2' x 3', 3' x 4', 4' x 4', 4' x 5', 4' x 6', 4' x 8', 4' x 10', and 4' x 12'

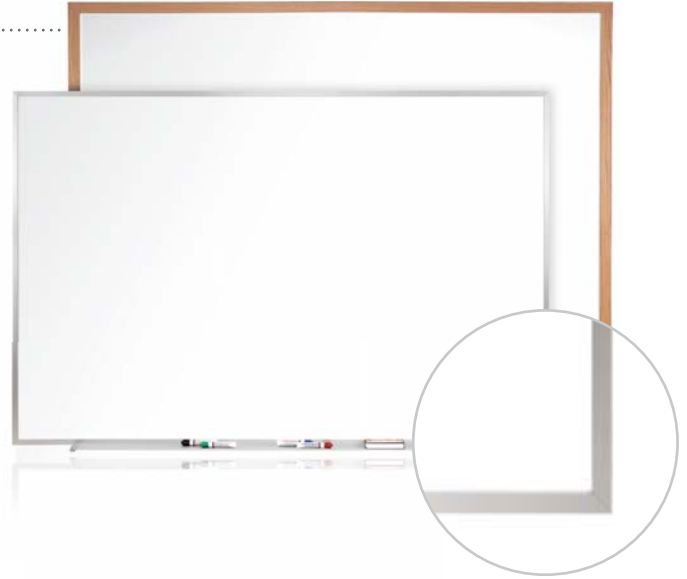

### Magnetic Porcelain with Box-Tray (A2M)

Satin aluminum-framed traditional porcelain whiteboards with detachable box-tray.

- Detached SmartPak Box-Tray is heavy-duty and ideal for easier installation and reduced potential for damage (map rail optional)
- Heavy-duty porcelain-on-steel surface on a 3/8" backing for years of dependable service. Available with 1" map rail
- Durable surface accepts magnets and resists scratches and stains
- Available in 4' x 6', 4' x 8', 4' x 10', 4' x 12', and 4' x 16'



### Proma Projection Surface (PRM1)

Porcelain whiteboard with ideal projection surface.

- Porcelain-on-steel projection surface in low luster finish minimizes "hot spots" and provides maximum color projection
- Magnetic surface resists scratches and stains
- SmartPak Tray is detached for easier installation and reduced potential for damage
- Satin aluminum frame with 1" map rail
- Available in 3' x 4', 4' x 4', 4' x 6', and 4' x 8'





### Magnetic Porcelain Image Trim Frame (ITGM)

Porcelain whiteboard in our Image Trim frame – a stylish powder-coated graphite fleck finish on aluminum frame.

- Premium magnetic porcelain-on-steel marker surface accepts magnets and resists scratches and staining
- SmartPak Tray is detached for easier installation and reduced potential for damage
- Stylish frame with unsurpassed durability
- Available in 4' x 6', 4' x 8', 4' x 10', and 4' x 12'



### DecoAurora (DFM)

Porcelain whiteboard with durable aluminum frame that features color-customization capability.

- Porcelain-on-steel surface accepts magnets and resists scratches and stains
- Stylish multi-faceted corners and aluminum framing
- Wood-look or color strips coordinate with interior furnishings and conceal mounting hardware
- Available in 3' x 4', 4' x 4', 4' x 6', 4' x 8', 4' x 10', and 4' x 12'



### DecoQuest (0450)

Porcelain whiteboard with a contemporary frame.

- Upscale porcelain-on-steel board accepts magnets and resists scratches and stains
- Slide-in accessory tray allows for mounting either portrait or landscape
- Aluminum framing with cherry laminate wrap on long sides and black powder coating on short sides
- Multi-faceted corners conceal hanging system
- Available in 2' x 3', 3' x 4', 4' x 6', and 4' x 8'



## GRAPHIC PORCELAIN WHITEBOARDS

### Penmanship Lined Boards (GM1P) & Music Staff Lined Boards (GM1M)

Functional porcelain whiteboard with a satin aluminum frame.

- Heavy-duty porcelain-on-steel surface on 3/8" backing
- Graphics available with either Penmanship lines or Music Staff
- Graphic surface accepts magnets and resists scratches and stains
- SmartPak Tray detached for easier installation, reduced damage potential – available with either marker tray (GM1) or premium box tray (GA2M) options
- Available in 4' x 6' and 4' x 8'
- GM1M – Distance between music staff lines = 1" and 4" between next set of staff lines
- GM1P – Distance between solid and dashed lines = 2"



## MAGNETIC STEEL WHITEBOARDS

### Magnetic Steel (M3 & M3W)

Traditional painted steel whiteboards with detachable marker tray, available in satin aluminum or wood frames.

- Durable acrylic enamel steel surface is built to last and perform
- High-quality surface accepts magnets and resists scratches and stains
- Available in either a satin-anodized aluminum or a solid oak frame
- SmartPak Tray is detached for easier installation and reduced potential for damage
- Available in 2' x 3', 3' x 4', 4' x 4', 4' x 5', 4' x 6', 4' x 8', 4' x 10', and 4' x 12'

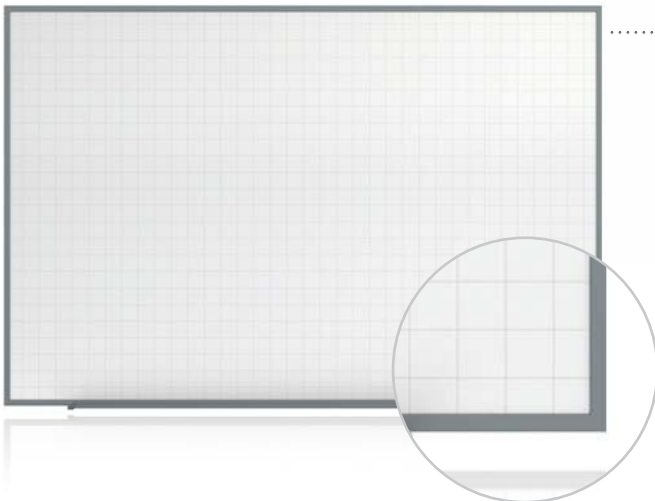
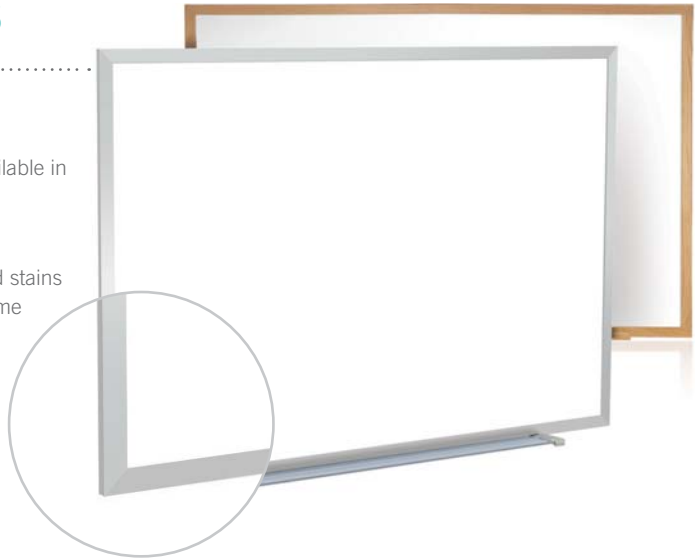

### Phantom – Magnetic Lined Boards (PLM3)

Painted steel whiteboard with faint grid lines only visible to user.

- 2" x 2" grid lines visible to the user, unseen by the audience
- Durable acrylic enamel steel surface priced to sell, last and perform
- High-quality magnetic steel resists scratches and stains and accepts magnets
- SmartPak Tray is detached for easier installation and reduced potential for damage
- Available in 2' x 3', 3' x 4', 4' x 4', 4' x 6', and 4' x 8'



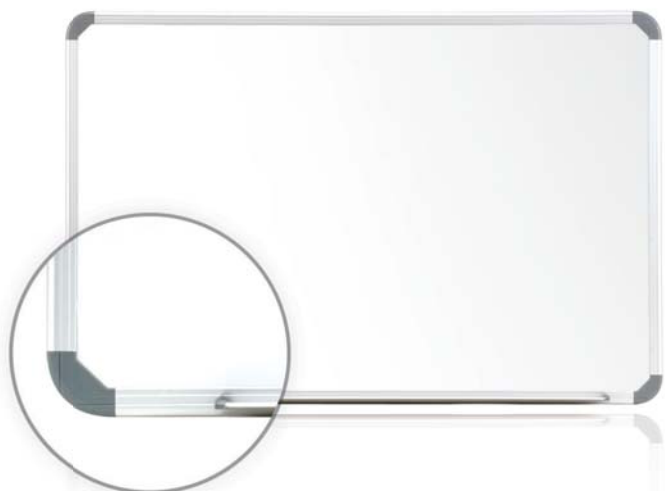

### Magnetic Steel with Cintra Frame (CTSM3)

Painted steel whiteboard in our Cintra frame – a European-style aluminum frame.

- Stylish radius edged, Euro-style satin aluminum frame
- Acrylic enamel white magnetic steel marker surface erases easily and resists ghosting
- Attachable accessory tray allows for portrait or landscape mounting
- Concealed hanging system provides sleek look
- Available in 1.5' x 2', 2' x 3', 3' x 4', 4' x 6', and 4' x 8'



## NON-MAGNETIC WHITEBOARDS

### Non-Magnetic Whiteboards (M2 & M2W)

Non-Magnetic whiteboards are an affordable whiteboard with a surface that writes and erases beautifully.

- Satin aluminum or natural oak, solid wood framing options
- 4' x 3' and smaller – 1/8" hardboard, attached marker tray
- 5' x 3' and larger – 1/4" hardboard, detached marker tray for easier installation and reduced damage potential
- Available in 2' x 3', 3' x 4', 4' x 4', 4' x 5', 4' x 6', 4' x 8', and 4' x 12' (aluminum frame only)

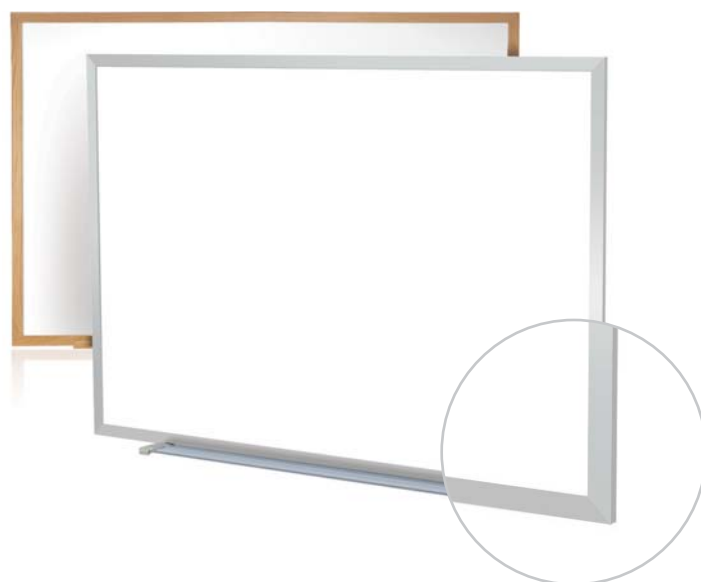

## RESURFACING SOLUTIONS

### Magnetic Porcelain Resurfacing (RNM1)

Renewal – Our custom-built porcelain whiteboards designed to fit exactly over existing framed boards.

- No need to remove old board – fits easily over existing framed board for installation cost savings
- Surface accepts magnets and resists scratches and stains
- Anodized satin aluminum frame with no marker tray
- Factory-drilled holes in aluminum frame for quick mounting; installs in minutes, includes mounting instructions and hardware
- Order exact size to be covered – includes frame, not tray



## RESURFACING SOLUTIONS

### PDQ Skins (PSC)

Porcelain sheets can be applied directly to wall or face of worn boards.

- Surface is white porcelain-on-steel
- PDQ sheets accept magnets and resist stains
- Includes disposable board that protects metal edges, assists with handling and prevents creases during installation
- Innovative installation method makes PDQ sheets simple to apply
- Available in 4' x 4', 4' x 6', 4' x 8', 4' x 10', 4' x 12', and custom sizes

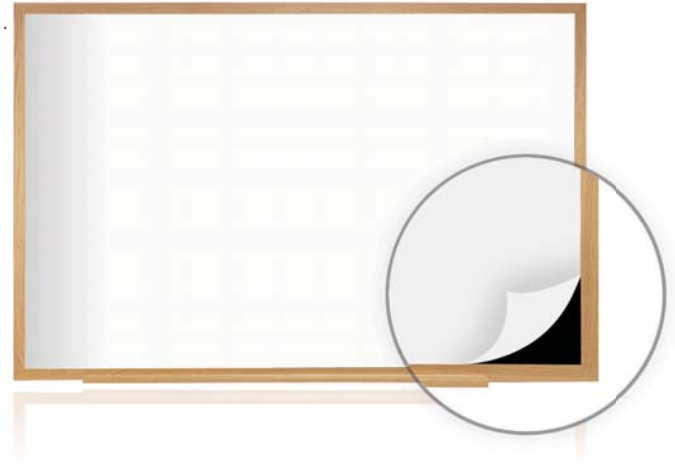

## WHITEBOARD ACCESSORIES

### Sparkleen (SPS), Markers (M4) & Erasers (ER)



- Sparkleen is specially formulated to cut through built-up residue faster and easier than any other whiteboard cleaner on the market
- Markers write easily and wipe off cleanly. Vivid colors combined with a wide chisel point leave an easy-to-read ink mark for effective communication. Standard colors: Black, Blue, Red, or Green
- Foam eraser outperforms its predecessors to give users a perfectly clean slate every time





$X = (-2)$

O=C1OC(c2ccc(O)cc2)c3ccccc13

$\left(\frac{f(x)}{g(x)}\right)$

$\frac{f(x+\Delta x) - f(x)}{\Delta x}$

$\log_a b^r = r \log_a b$

$\sin X = a$

$c \log_b a$

$\log_a 2$

$\cos \alpha$

$S_{\Delta} = \sqrt{P(P-a)}$

$\cos \alpha$

$\lim_{\Delta x \rightarrow 0} \frac{\Delta x}{\Delta x}$

4' x 8' Magnetic Steel whiteboard with wood frame.

## COMMUNICATION FURNITURE

### VisuALL PC (413)

Combined whiteboard surface with a useful fabric bulletin board in an enclosed system for discretion.

- Opens to an ample 6' of whiteboard surface
- Closes to 3' of convenient fabric bulletin board
- Cabinet measures 2' x 3' closed
- Available in choice of Gray, Blue, or Beige fabric
- Comes complete with mounting accessories for easy attachment to walls or for hanging from divider panels

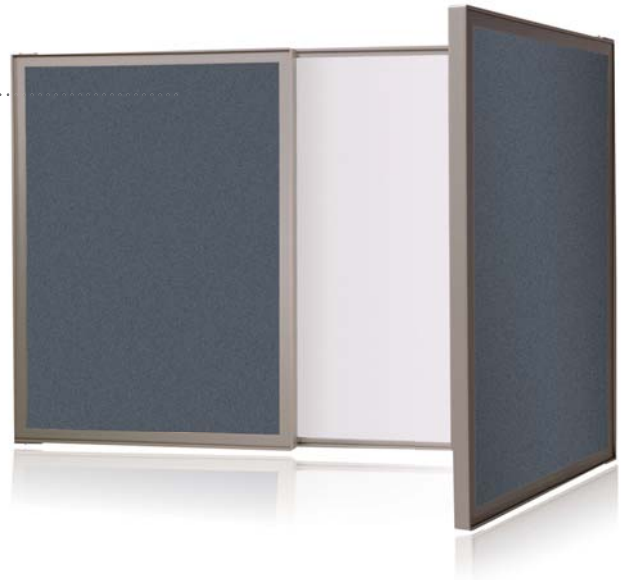

### Conference Cabinets (C1)

Mahogany or Oak cabinets with magnetic porcelain whiteboard and tackable surfaces.

- These sturdy units feature top-quality Mahogany or Medium Oak laminate surface with hinged doors and magnetic door latches
- Self-healing natural cork bulletin boards line the inside of both doors
- Interior depth of 3" allows for marker and eraser storage when closed
- Cabinet measures 4' x 4' closed and extends 5" from the wall
- Doors can be customized with whiteboard surface



### Horizontal Sliders (HSM)

Sliders provide multiple whiteboard panels to serve a multitude of needs.

- Horizontal Sliders uses a porcelain whiteboard surface creating a durable, high-performance board that resists scratches and stains
- Doubles amount of usable space with fixed back panel and two sliding writing panels – up to 288" of horizontal writing surface
- Top-suspended panels glide on nylon rollers for smooth operation
- Accepts magnets and magnetized accessories
- Constructed with heavy-duty anodized aluminum trim
- Available in 4' x 6', 4' x 8', 4' x 10', and 4' x 12'







Whiteboard content:

- Left side: A chemical structure diagram with labels "NO" and "OH", and the fraction  $\frac{f(x)}{g(x)}$ . Below it is the expression  $X = (-2)$ .
- Center: The difference quotient formula  $\frac{f(x+\Delta x) - f(x)}{\Delta x}$ .
- Right side: Logarithmic identities  $\log_a b^r = r \log_a b$  and  $\log_a c = \frac{\log c}{\log a}$ . Trigonometric identities  $\sin X = a$  and  $\cos X$ . A Bohr-style atomic model with a central nucleus and three elliptical orbits. A small coordinate system with axes  $x$  and  $y$ , and a point  $X \rightarrow 0$  on the  $x$ -axis.

# MOBILE WHITEBOARDS

Mobile and Rolling Collaboration Products



**Movement promotes brainstorming – why stand still?**

Ghent's line of mobile, reversible, and rolling whiteboards allow for brainstorming and collaboration when wall space isn't available. Modern design meets durability for a mobile whiteboard solution that will fit into any space.



3 Roam mobile whiteboards shown nested.

## ROAM

### Roam (ROAMXX1)

- Double-sided mobile whiteboard with edge-to-edge writing surface workspace for personal use or group interaction
- 36" x 42" writing surface constructed of non-ghosting, high-pressure laminate
- Satin aluminum double-sided tray and legs complement any décor
- Constructed with 2.5" heavy-duty casters that allow for ease of use throughout any flooring surface
- Compact nesting allows for multiple units to fit within the same footprint
- Low center of gravity creates stability in use and while roaming
- Optimal for seated or standing positions
- Lightweight – complete unit only weighs 24 lbs, overall dimensions are 36" x 68.5"



## REVERSIBLE BOARDS

### Mobile Whiteboards (AR & R)

Double-sided mobile whiteboard, available in satin aluminum or wood frames in magnetic porcelain or non-magnetic writing surfaces.

- Reversing mechanism designed to make flipping to the other side easy
- Steel lock clamps adjust to secure board to preferred position
- Reinforced legs have added bracing for stability and security
- Satin finish anodized aluminum frame – 4 casters, 2 locking wheels included; Natural Oak finish solid wood frame – casters sold separately
- Available in marker/marker, marker/cork, cork/cork
- 4' x 3' and 6' x 4' options available





## NEXUS

## Tablet (NEX106TM)

The Nexus Tablet is a lightweight and portable solution that provides a markerboard workspace for use wherever it is needed.

- Right-sized – spacious 28" x 28" double-sided, high-pressure laminate whiteboard workspace for personal use or group interaction
- Compact – simple to move from room to room and pack away for storage
- Lightweight – weighing only 3 lbs, the tablet is perfect for break-out sessions
- Environmentally friendly – more durable, reusable, and greener solution than traditional chart pads



## Easel+ (NEX204EP)

Nexus Easel+ combines the best parts of the Nexus family into one product. Featuring the usability and writing surface of the Easel, the tablet-storage space of the Caddy plus double the hanging space, the Easel+ is one of the most versatile whiteboards on the market.

- Double-sided 76" x 40.375" porcelain whiteboard – more durable, reusable, and green
- Angled foot design – allows units to be grouped for a more coordinated collaboration space
- Expandable workspace – attached side pegs give you the option of adding Tablets for additional room
- Sleek and contemporary frosted glass paneling, allows Nexus to cohesively fit with any decor
- Customizable surface options: marker/marker, marker/tack, and tack/tack



## IdeaWall (NEX206MW)

The Nexus IdeaWall is a mobile-porcelain whiteboard with an extra-large 46" x 68.5" magnetic work surface and expandable presentation space.

- Double-sided, 46" x 68.5" porcelain whiteboard – more durable, reusable
- Angled foot design – allows units to be grouped for a more coordinated collaboration space
- Expandable workspace – attached side pegs give you the option of adding Tablets for additional room
- Sleek and contemporary frosted glass paneling, allows Nexus to cohesively fit with any decor
- Customizable surface options: marker/marker, marker/tack, and tack/tack



## Easel (NEX203ME)

The Nexus Easel is a mobile, double-sided whiteboard that provides a flexible magnetic 46" x 34.5" writing area plus expandable workspace for tablets.

- Double-sided, 46" x 34.5" porcelain whiteboard – more durable, reusable, and green
- Angled foot design – allows units to be grouped for a more coordinated collaboration space
- Expandable workspace – attached side pegs give you the option of adding Tablets for additional writing space
- Sleek and contemporary frosted glass paneling, allows Nexus to cohesively fit with any decor
- Customizable surface options: marker/marker, marker/tack, and tack/tack



## Partition (NEX224)

The Nexus Partition is a mobile whiteboard with an extra-large 65" x 46.5" whiteboard work surface and expandable presentation space.

- Double-sided, 65" x 46.5" magnetic porcelain marker surface – more durable, reusable, and green
- Angled foot design – allows units to be grouped for a more collaborative space
- Expandable workspace – attached side pegs give you the option of adding Tablets for additional room
- Divide and conquer – Nexus Partition allows small groups to partition off their space to collaborate on a beautiful writing surface while minimizing distractions
- Available in marker/marker, marker/tack, and tack/tack options (see page 62 for all surfaces)



## Jr. Partition (NEX223)

The Nexus Jr. Partition is a mobile whiteboard with a compact 46" x 34.5" work surface and expandable presentation space – perfect for seated-height applications.

- Sized for seated comfort – the size of the Jr. Partition is perfect for small group collaboration, especially for the seated position and is ADA compliant
- Double-sided, 46" x 34.5" magnetic marker surface – more durable, reusable, and greener solution than traditional chart pads
- Expandable workspace – attachable easel pegs give you the option of adding Tablets for additional room
- Available in marker/marker, marker/tack, and tack/tack options (see page 62 for all surfaces)



## WallBoard (NEX-WMB)

The Nexus WallBoard is a traditional stationary display panel with a porcelain whiteboard work surface.

- Stylish Nexus design allows the WallBoard to seamlessly match your other Nexus products
- Brings Nexus beyond wheels and onto walls, so all collaborators can enjoy the style, performance, and durability of Nexus
- Available in 36" x 48" and 48" x 72"



## Caddy (NEX201TC)

The Nexus Caddy is an all-in-one mobile cart that stores and transports up to six Tablet markerboards and is also able to function together with a Tablet to create a presentation easel.

- All-in-one solution – can hold six Tablets in a compact space while displaying a Tablet for use
- Flexible presentation space – a single Tablet markerboard can be mounted centrally on the Caddy
- Angled foot design – allows units to be grouped for a more coordinated collaboration space
- Dual functionality – use it as a mobile storage cart or as a markerboard easel
- Sleek and contemporary frosted glass paneling, allows Nexus to cohesively fit with any decor
- Tablets sold separately



## X-Pegs & X-Hangers (NEX006XP | NEX011XHS)

Nexus X-Pegs are a flexible, low-profile display system for Tablet whiteboards that accommodate a variety of wall-mounting options. The Nexus X-Hangers adjust to fit snugly onto various thicknesses of dividers.

### X-Pegs

- Low-profile wall visibility – requires only a single pair of X-Pegs per Tablet markerboard
- Flexible mounting options – X-Peg pairs can be mounted in a single row for presenting a line of multiple Tablets or in multiple rows for upper-level image display and lower-level writing
- Easy to hang – attaches to wall with single fastener

### X-Hangers

- Panel hangers adjust to fit snugly onto various thicknesses of dividers
- Simple to use – Tablet corner designed with X-Hanger sizes opening for intuitive connection and fit
- Easy to hang – attaches onto top of partition with thumb screws to secure into position

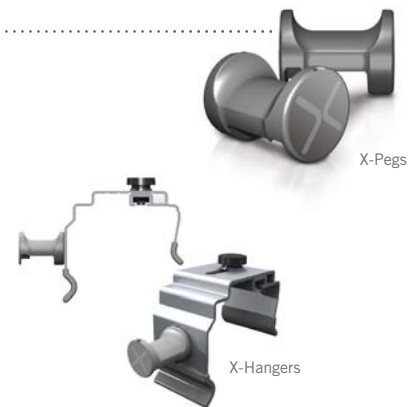





Conducting Market Research



Meeting notes and documents on the table whiteboard.

# BULLETIN BOARDS

Premium Frame & Surface Selections



”

Share and post what matters with pride

Display your messages and announcements in style. With many frame options, and even more surface options, you'll find a bulletin board that's just right for you.

### Tack on More Options

Many of our products can be customized with one of hundreds of different tack surfaces offered in a variety of colors. Visit pages 61–62 or go to [ghent.com/finishes](http://ghent.com/finishes) to learn more.



3' x 4' Cork bulletin board with aluminum frame.

## PREMIUM CORK BULLETIN BOARDS

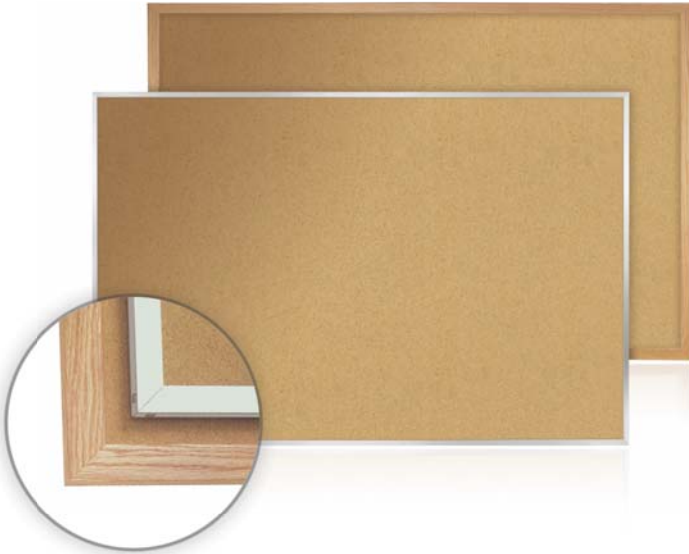

### Premium Aluminum (059) & Wood (066)

Cork bulletin board with premium frame and our thickest and most durable cork, available in aluminum or wood frames.

- Surface is smooth, resilient, and self-healing to remain soft and pliable for years
- Thicker, upscale frame available in smooth aluminum and wood
- 3/8" sealed back fiberboard for rigidity and stability
- Available in 1.5' x 2', 2' x 3', 2.5' x 3', 3' x 4', 4' x 4', 4' x 5', 4' x 6', and 4' x 8'



## TRADITIONAL CORK BULLETIN BOARDS

### Aluminum (AK, 13) & Wood (WK, 14)

Cork bulletin board available in aluminum or wood frames.

- Self-healing cork surface
- Framing available in Satin-Anodized aluminum or Natural Oak
- Durable enough to provide years of service, even under the heaviest use
- Cork laminated on a 3/8" fiberboard for rigidity and stability
- Available in 1.5' x 2', 2' x 3', 2.5' x 3', 3' x 4', 4' x 4', 4' x 5', 4' x 6', 4' x 8', 4' x 10', and 4' x 12'



### Image Trim (ITGK)

Cork bulletin board in stylish powder-coated frame.

- Self-healing cork surface
- Stylish powder-coated graphite fleck finish on aluminum frame
- Durable enough to provide years of service, even under the heaviest use
- Cork laminated on a 3/8" fiberboard for rigidity and stability
- Available in 4' x 6', 4' x 8', 4' x 10', and 4' x 12'



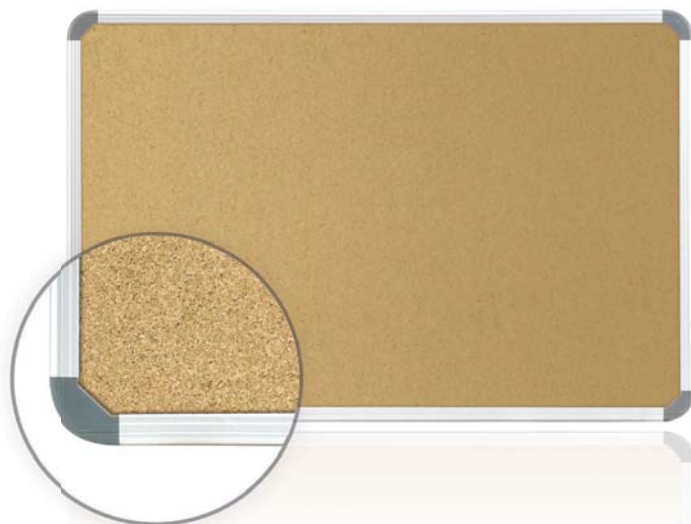

### Cintra (CTSK)

Cork bulletin board in European-style aluminum frame.

- Premium self-healing natural cork surface
- Stylish radius edged, Euro-style satin aluminum frame
- Can be mounted either portrait or landscape
- Concealed hanging system for secure wall mounting
- Available in 1.5' x 2', 2' x 3', 3' x 4', 4' x 6', and 4' x 8'



## RECYCLED RUBBER BULLETIN BOARDS

### Aluminum (ATR)

Recycled rubber bulletin board with aluminum frame.

- Go "GREEN" – tack surface manufactured from 90% post-industrial material
- Satin Aluminum frame is 75% post-industrial material
- Tack surface is self-healing and will stand up under the heaviest of use
- Surfaces available in Confetti (CF), Tan Speckled (TN), and Black (BK)

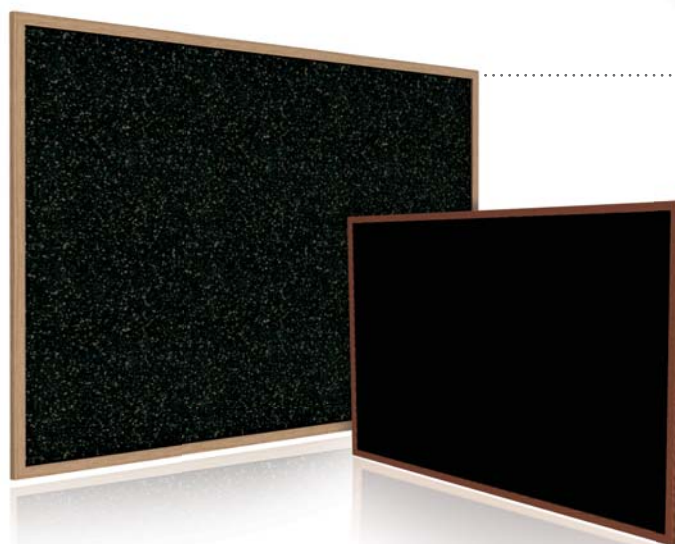

### Cherry Oak (WTRC) & Oak (WTR)

Recycled rubber bulletin board with Cherry Oak and Natural Oak frame options.

- Go "GREEN" – tack surface manufactured from 90% post-industrial material
- Natural Oak and Cherry Oak framing options
- Tack surface is self-healing and will stand up under the heaviest of use
- Surfaces available in Confetti (CF), Tan Speckled (TN), and Black (BK)





## VINYL BULLETIN BOARDS

### Aluminum (AV, 16) & Wrapped (12UVW)

Vinyl bulletin board, aluminum framed or wrapped edges.

- Fabric-backed 12 oz. vinyl laminated to 3/8" fiberboard
- Texture masks pin holes and vinyl is washable for areas where cleanliness is extra important
- Frame is satin finish anodized aluminum
- Choice of 10 contemporary colors (see page 62)
- Both aluminum frame and wrapped available in 1.5' x 2', 2' x 3', 2.5' x 3', 3' x 4', 3' x 5', 4' x 4', 4' x 5', 4' x 6', 4' x 8', 4' x 10', and 4' x 12'



### DecoAurora (DFV)

Vinyl bulletin board in designer DecoAurora frame.

- Stylish multi-faceted corners and aluminum framing
- Frame inserts available in three rich wood looks and seven bold colors that coordinate with interior furnishings
- Vinyl gray color surface is durable and washable
- Textured surface hides pinholes for added durability and product life
- Available in 3' x 4', 4' x 4', 4' x 6', 4' x 8', 4' x 10', and 4' x 12'

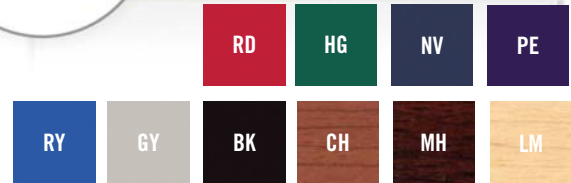
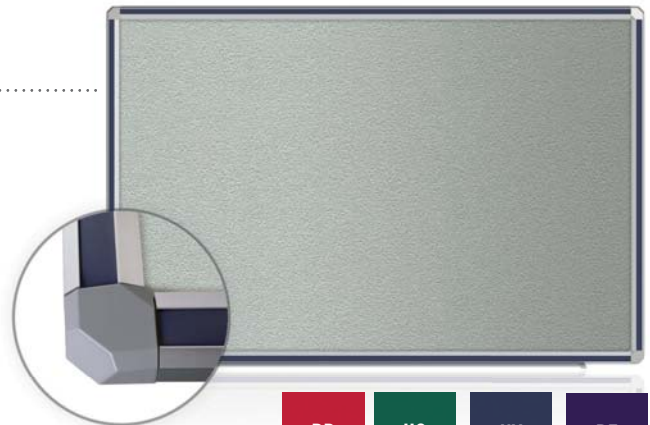

## FABRIC BULLETIN BOARDS

### Wrapped Edge (TF)

Wrapped-edge fabric boards add style to offices, conference rooms, classrooms, and corridors while providing a sturdy tack surface for posters, announcements, and other notices.

- The warm fabrics are colorfast and will remain free from damage even after years of repeated tacking
- The soft, radius corners and fabric edge design make a tasteful addition to any décor
- Available in five fashion colors: Gray, Beige, Blue, Black and Merlot
- Available in 1' x 4', 1.5' x 2', 2' x 3', 3' x 4', and 4' x 6'



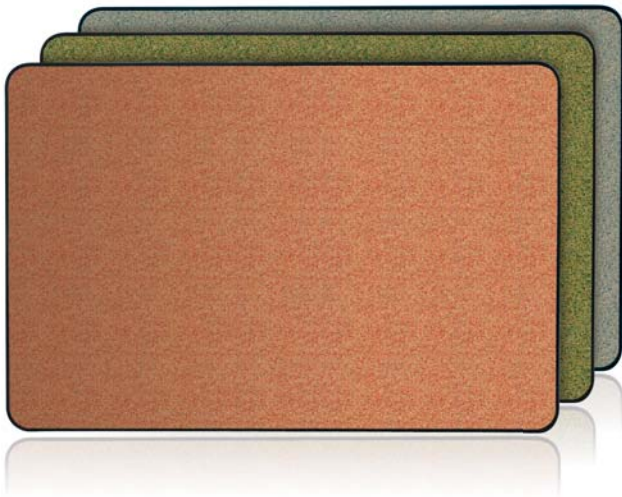

## COLORED CORK BULLETIN BOARDS

### Gemini Colored Cork (TG)

- Natural cork is self-healing and masks pin holes created by repeated tacking
- Available in premium Red, Blue or Green cork
- Board can be hung horizontally or vertically
- Holds push pins, staples and tacks firmly
- Available in 1.5' x 2', 2' x 3', and 3' x 4'



## COMBINATION BOARDS

### Combo Boards (SPC)

- Modular solution saves time and money
- Easily replaceable sections
- Porcelain surface will accept magnets, resists scratches and stains
- Tack surface – 10 vinyl colors, 3 recycled rubber colors (see page 62) and natural cork options to seamlessly match any classroom or office
- Frame is satin-anodized aluminum
- Includes 1" map rail, tray with protective end caps
- SmartPak Tray detached for easier installation, reduced damage potential

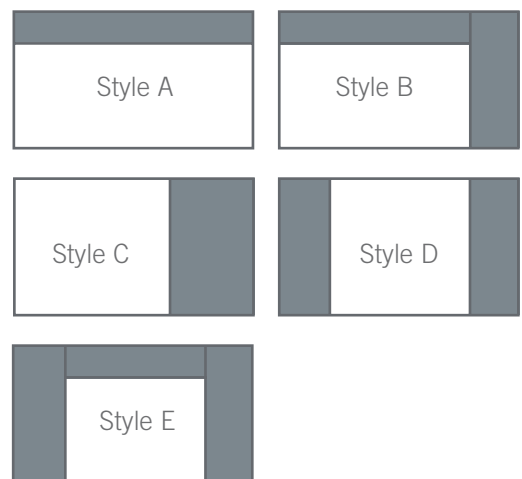

# ENCLOSED & LETTER BOARDS

Indoor, Outdoor, Lighted, Custom, & Economical



**Showcasing what's important**

What you have to say is important, and it needs to be secure. We have a wide selection of enclosed message centers for any environment or purpose: Indoor, Outdoor, Lighted, Custom, Designer, Economical. See for yourself why our enclosed message centers look nicer, perform better, and last longer.

### Quality is What Sets Us Apart

Our enclosed bulletin boards are superior when compared to alternatives. With American craftsmanship using premium materials for longevity, our enclosed boards stand the test of time. Go to [ghent.com/enclosedquality](http://ghent.com/enclosedquality) to learn more.





Indoor Enclosed Message Center.

## ENCLOSED BULLETIN BOARDS

### Silhouette (SILH)

Silhouette provides an upscale appearance for a wall-mounted enclosed bulletin board with a sleek, contemporary look that maximizes the viewing and display area.

- Unique size allows for nine letter-sized sheets of paper to be completely visible in the viewing area
- Unframed tempered glass door allows for full viewing of what is on display
- Can be mounted to open to either the left or the right
- Modular design allows the freedom to use one or multiple units side-by-side
- Frame options: Satin Aluminum, Wood-look Cherry, Light Maple, and Black
- Size: 2.31' x 3.51' x 0.16'



### Ovation (OVK & OVG)

Designer enclosed bulletin board with aluminum frame and radius corners.

- Enclosed bulletin boards feature stylish radius corners
- Powder-coated aluminum framing in Black (OVK) or Gray (OVG) matte finish
- Tack surface is fade-resistant and will hold up under the most demanding use
- Concealed corner brackets allow for easy and secure mounting
- Fabric available in Black, Gray, Merlot, Blue, or Beige
- Available with sliding or hinged doors; includes lock for added security
- Available in 1 (2' x 2.83'), 2 (3.92' x 2.83' or 5' x 3'), and 3-door (6' x 4')



## INDOOR ENCLOSED BULLETIN BOARDS

### Cork (PA, PB, PW, PN & PWC)

Traditional enclosed cork bulletin board in a variety of frame options.

- Available in Satin Aluminum (PA), Bronze (PB), Natural Oak (PW), Walnut (PN), and Cherry Oak (PWC) framing
- Doors feature shatter-resistant acrylic panels
- Flush-mount locks for added security
- Self-healing natural cork surface will withstand repeated tacking
- Concealed corner brackets for easy and secure mounting
- Available in 1, 2, and 3-door options and tack or dry-erase surface



## Recycled Rubber (PA\_TR, PB\_TR, PW\_TR, PN\_TR & PWC\_TR)

Recycled Rubber enclosed bulletin board in a variety of frame options.

- Go “GREEN” – tack surface manufactured from 90% post-industrial material
- Available in Satin Aluminum (PA), Bronze (PB), Natural Oak (PW), Walnut (PN), and Cherry Oak (PWC) framing
- Self-healing recycled rubber tack surface hides pin holes
- Available in 3 tack surface colors – Black (BK), Confetti (CF), and Tan Speckled (TN)
- Doors feature shatter-resistant acrylic panels, flush-mount locks for added security
- Concealed corner brackets for easy and secure mounting
- Available in 1, 2, and 3-door options



## Fabric (PA\_F, PB\_F, PW\_F, PN\_F & PWC\_F) Vinyl (PA\_VX, PB\_VX, PW\_VX, PN\_VX & PWC\_VX)

Traditional enclosed bulletin board in a variety of frame options, featuring a vinyl or fabric tackable surface.

- Available in Satin Aluminum (PA), Bronze (PB), Natural Oak (PW), Walnut (PN), and Cherry Oak (PWC) framing
- Doors feature full-length hinges and shatter-resistant acrylic panels
- Flush-mount locks for added security
- Available in 5 fabrics and 10 vinyl tack surface colors
- Concealed corner brackets for easy and secure mounting
- Available in 1, 2, and 3-door options



## OUTDOOR ENCLOSED BULLETIN BOARDS

### Vinyl (PA\_VX & PB\_VX)

Outdoor vinyl enclosed bulletin board.

- Weather-resistant design to display and protect important information
- Frame available in Satin (PA) or Bronze (PB) finish anodized aluminum
- All units feature shatter-resistant acrylic doors
- Includes flush-mount locks for added security
- Concealed corner brackets for easy and secure mounting
- Available in 1, 2, and 3-door options and 10 color options (see page 62)



**NOTE:** For outdoor use, unit should be mounted under an awning or overhang

## CUSTOMIZED ENCLOSED



### Indoor Headliner (PAK & PBK)

Indoor cork enclosed bulletin board with customizable header.

- Frame available in Satin (PA) or Bronze (PB) finish anodized aluminum
- All units feature shatter-resistant acrylic doors
- Include flush-mount locks for added security
- Natural cork surface is self-healing and will withstand repeated tacking
- Lighted header panel option available
- Concealed corner brackets for easy and secure mounting
- Available in 1, 2, and 3-door options



### Outdoor Headliner (PA-VX & PB-VX)

Outdoor vinyl enclosed bulletin board with customizable header.

- Weather-resistant design to display and protect important information
- Frame available in Satin (PA) or Bronze (PB) finish anodized aluminum
- All units feature shatter-resistant acrylic doors
- Include flush-mount locks and 2 keys for added security
- Vinyl fabric tack surface with sealed back for outdoor use (available in 10 colors)
- Lighted header panel option available
- Available in 1, 2, and 3-door options



**NOTE:** For outdoor use; unit should be mounted under an awning or overhang



## LIGHTED ENCLOSED BULLETIN BOARDS

### Concealed Light (CPA)

- Concealed lighting to spotlight and attract attention to your display
- Satin-anodized aluminum frame
- Doors feature full-length hinges, shatter-resistant acrylic panels and flush-mount locks
- Self-healing natural cork surface will withstand repeated tacking
- Concealed corner brackets for easy and secure mounting
- Available in 1, 2, and 3-door options



## ENCLOSED LETTER BOARDS



### Indoor Letter Boards (PA\_B, PB\_B, PW\_B, PN\_B, PWC\_B)

- Available in Satin Aluminum (PA), Bronze (PB), Natural Oak (PW), Walnut (PN), and Cherry Oak (PWC) framing options
- Doors feature shatter-resistant acrylic panels
- Flush-mount locks for added security
- Black or Burgundy flannel letter panel – 1/4" precision grooves for easy letter insertion
- Set of 3/4" Gothic font white letters, numbers and characters (327 pieces included)
- Concealed corner brackets for easy and secure mounting
- Available in 1, 2, and 3-door options



### Outdoor Letter Board (PA\_BX & PB\_BX)

- Weather-resistant durable anodized aluminum frame in Bronze or Satin finish
- Doors feature shatter-resistant acrylic panels
- Flush-mount locks for added security
- Black or Burgundy vinyl letter panel with 1/4" precision grooves for easy letter insertion
- Set of 3/4" Gothic font white letters, numbers, and characters (327 pieces included)
- Available in 1, 2, and 3-door options

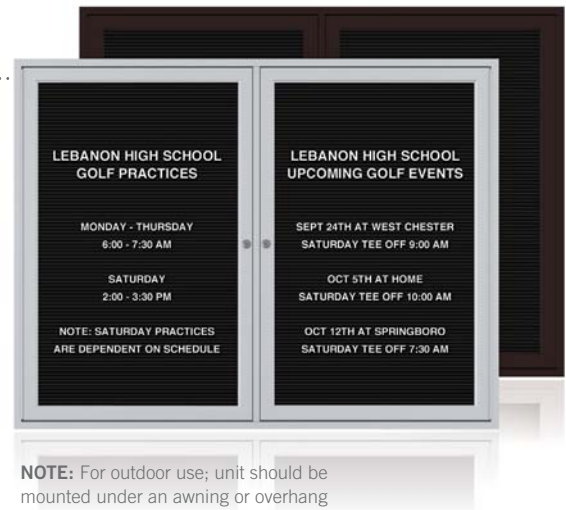

## LETTER BOARDS

### Ovation (OVG & OVK)

- Make changes easily and keep your message secure
- Detailed, stylish radius corners
- Frame is powder-coated aluminum available in Black (OVK) or Gray (OVG) matte finish
- Black or Burgundy flannel letter panel with 1/4" precision grooves for easy letter insertion
- Set of 3/4" Gothic font white letters, numbers, and characters (327 pieces)
- Available with sliding or hinged doors; includes lock and key for added security
- Concealed corner brackets allow for easy and secure mounting



## CUSTOMIZED ENCLOSED LETTER BOARDS

### Headliner Letter Board (PAB & PBB)

- Aluminum frame available in Satin (PA) or Bronze (PB) finish
- Available in both indoor and outdoor models
- Doors feature full-length hinges, shatter-resistant acrylic panels and locks
- Black flannel (indoor) or vinyl (outdoor) letter panel with 1/4" precision grooves for easy letter insertion
- Set of 3/4" Gothic font white letters, numbers and characters (327 pieces included)
- 6" high opaque acrylic header panel, customized message, lighted option
- Concealed corner brackets for easy and secure mounting
- Available in 1, 2, and 3-door options

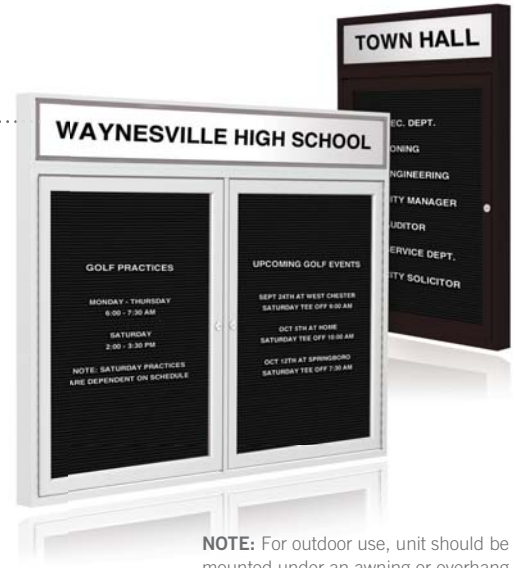

**NOTE:** For outdoor use, unit should be mounted under an awning or overhang

## PEDESTAL SIGNAGE

### Sentry Freestanding Message Center (ZPA & ZPB)

This message center is ideal for lobbies, hotels, and conference centers.

- Frame available in Satin or Dark Bronze anodized aluminum
- Message center stands 2.67' x 5.67'
- Large letterboard 2.5' x 3', with locking acrylic door
- Black flannel board has 1/4" precision grooves for easy letter insertion
- Set of 3/4" Gothic font white letters, numbers, and characters (327 pieces)





## Single Pedestal Message Center (PD)

- Stand features a weighted base for increased stability and security
- Pedestal letterboard adjusts in height from 4.08' to 4.67'
- Available with black plastic letter panel 2' x 1.5' and framed in satin anodized aluminum
- Letter panel has 1/4" precision grooves for easy letter insertion and available with cork surfaces
- Includes set of 3/4" Gothic font white letters, numbers, and characters (327 pieces)
- Ideal for lobbies, hallways, and waiting areas



## Double Pedestal Letter Board (HPD)

Traditional pedestal signage with two legs and weighted base – perfect for high-traffic areas.

- Base is black powder-coated aluminum, legs are black powder-coated steel
- Pedestal letterboard stands 5' high
- Black flannel letter panel 2' x 1.5' is framed in Satin anodized aluminum
- Letter panel has 1/4" precision grooves for easy letter insertion
- Set of 3/4" Gothic font white letters, numbers, and characters (327 pieces)
- Available in open-face or acrylic-covered letterboard design



# EASELS & DISPLAY RAILS

Lobbies, Hotels, & Conference Centers



“  
**We all have  
something to display**

Sometimes your messages need to be displayed in multiple places. Our easels and display rails allow you to be versatile as you communicate wherever that may be.





## DISPLAY EASELS

### Telescoping Presentation Easel (1050 & 1060)

Presentation easels and accessories are a must for brainstorming sessions, meetings, and sales conferences.

- Available in Satin (1060) or Black (1050) anodized aluminum
- Telescoping legs adjust from 2.83' to 5.33' high
- Non-skid feet and adjustable board holders add to its versatility
- Can be used with a whiteboard



### Triumph (19250)

- Constructed of ABS gray resin for a lightweight easel
- Holds up to 25 lbs, yet weighs just 3 lbs
- Adjustable to 3.08' table top or 5.17' full size
- Features retractable legs, permanent positioned placard/board holders, and non-marring feet
- Uses include displaying presentations, artwork, posters, and small boards



## PRESENTATION EASELS

### Magnetic Marker Easel (1040M3)

Aluminum-framed magnetic markerboard permanently attached to a telescoping easel.

- Can be used as either table top or full size – up to 5.42' tall
- Large steel markerboard measures 2.33' x 2.92' and accepts magnets
- Full-length flipchart bar and marker tray
- Skid-resistant, rubber-tipped legs



## PRESENTATION EASELS

### Attivo (19982)

Easy-to-transport briefcase that transforms in seconds into a full-sized whiteboard.

- Opens to a full-sized dry erase board that measures 2.96' x 1.96'
- Telescoping aluminum legs extend for stability
- Durable case measures 2.63' x 1.65' x 0.33' when closed
- Features built-in marker and eraser storage and convenient carry strap



## DISPLAY RAILS



### Hold-Up (H)

Creative and safe solution to displaying memos, reminders, and artwork.

- No need for tape, tacks, or pushpins
- Allows the flexibility to post thick and thin items side by side
- Can be attached to the top of a board or mounted separately
- Clear front lets entire paper show while blending in with any surface
- Versatile enough for the school hallway, refrigerator, or office filing cabinet
- Available in 1', 1.5', 2', 3', 4', 5', 6', and 8'



# CHOOSE THE **WRITE** SURFACE

We pride ourselves on being whiteboard experts. Different environments and applications require different solutions – and that’s what we are proud to offer our customers. Below is a simple guide to choosing the perfect writing surface for your world.

**ACRYLITE™ WHITEBOARDS**  
High Performance Acrylic  
and will not ghost



- Half the weight of glass
- Twice the scratch resistance of glass
- Polished edges and superior performance



**GLASS MARKERBOARDS**  
Tempered and will not ghost



- 1/4" tempered glass will not ghost
- Variety of styles, colors, and even magnetic
- The ultimate style statement



**PORCELAIN**  
A classic; guaranteed to not ghost



- Non-porous surface will not ghost
- Writes clearly and erases cleanly
- Surface accepts magnets



**POWDER COATED**  
Write in places  
like never before



- High performance powder coat on steel
- Multiple colors available
- Surface accepts magnets



**PAINTED STEEL**  
A magnetic, durable option



- Multiple layers of coating on steel
- Good performance at a great price point
- Surface accepts magnets



**NON-MAGNETIC**  
Collaborate on a budget



- Painted hardboard surface
- Good option for those on a budget
- Surface is non-magnetic



For more information about cleaning, marker removal, quality, and value of our surfaces visit

# PICK THE BRIGHT SOLUTION

Want to customize Ghent products with fabric to complement your decor? It's easy with our Tiered Fabric Program! The program consists of three tiers, or options, that allow you to choose from top of the line textiles, along with the ability to customize with your own material. To learn more about our fabric options, visit [www.ghent.com/finishes](http://www.ghent.com/finishes).

## 1 Tier 1: Guilford of Maine

Tier 1, consists of five fabric options from Guilford of Maine. Guilford of Maine, the open line brand of True Textiles, Inc., provides woven textile products focusing on the acoustic, healthcare, hospitality, education, and office markets, or any other application where high performance textiles are demanded.



## 2 Tier 2: Maharam

Together, Ghent and Maharam have developed our Tier 2 fabric program containing 124 textile designs in four patterns, Messenger, Medium, Manner, and Metric. Founded in 1902, Maharam is recognized for its rigorous and holistic commitment to design as a leading provider of textiles to architects and interior designers.



## 3 Tier 3: Custom

Want to incorporate your own fabric into our products? You've come to the right place! With our Tier 3 fabric program, you can match other fabrics in your interiors seamlessly by sending us your own fabric to be included in our products.



# TACK ON EVEN MORE OPTIONS

We've proudly been making bulletin boards since 1976. Over time, we've developed hundreds of ways to help people get their messages across. Below is a snapshot of our tack surface guide. Most surfaces are available in all of our bulletin board products.

## Tier 1 Fabrics

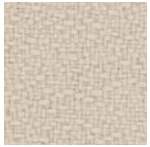

90  
Beige

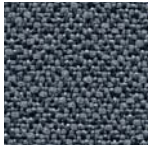

91  
Gray



92  
Merlot



93  
Blue



95  
Black

## Cork



Traditional  
Cork

## PremaTak Vinyls



181  
Caramel



183  
Ebony

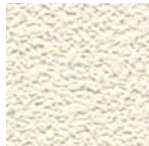

185  
Ivory



187  
Berry

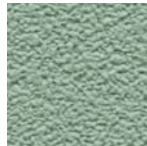

189  
Mint

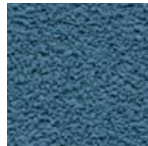

191  
Ocean

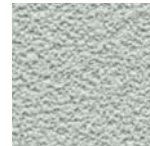

193  
Silver



195  
Navy

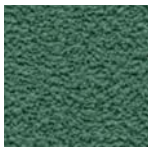

197  
Spruce



199  
Stone

Visit [ghent.com/finishes](http://ghent.com/finishes)  
for complete fabric options

## Colored Cork

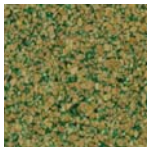

Green

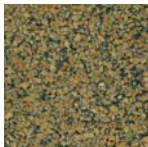

Blue

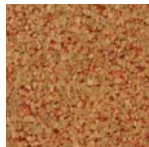

Red



Confetti

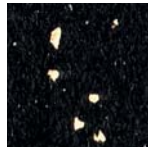

Tan



Black

## Flair Fabrics



201  
Twilight

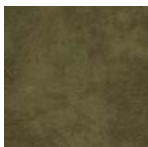

202  
Forest



203  
Cabernet

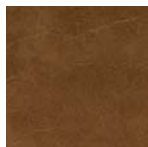

204  
Camel



205  
Charcoal

## Letterboards



Black



Burgundy

**FOR ADDITIONAL SURFACE OPTIONS**

visit [ghent.com/finishes](http://ghent.com/finishes)

# FRAMING THE CONVERSATION

We think we have a frame for everyone. Below is a quick reference guide for many of our frames styles for whiteboards, bulletin boards, and enclosed message centers.

## Standard Whiteboard & Bulletin Board Frames

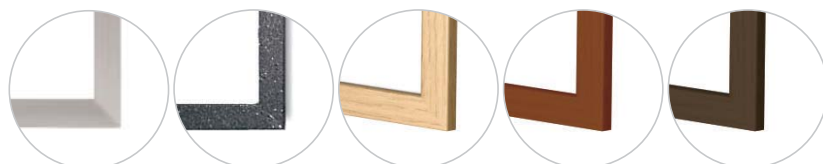

Satin Aluminum

Image Trim

Natural

Cherry

Walnut

## Deco Frames



DecoVue

DecoQuest

DecoAurora

## Enclosed Frames



Satin Aluminum

Bronze

Natural

Cherry

Walnut

## Ovation Frames

Wood-look  
CherryWood-look  
Light Maple

Black

Gray

## Silhouette Frames



Satin

Black

Wood-look  
CherryWood-look  
Light Maple

## Impression Classic Frames



Cherry

Espresso

Maple

Walnut

## Impression Modern Frames

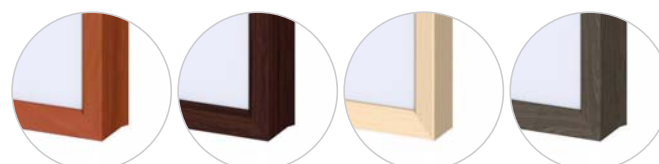

Cherry

Espresso

Maple

Walnut

**FOR MORE DETAILS**  
visit [ghent.com/finishes](http://ghent.com/finishes)



a **GMI** company.

.....

# Custom Dry-Erase Boards



VividBoard, a sister company of Ghent, offers graphically enhanced, custom, dry-erase boards to communicate what matters most without sacrificing your brand. Take your generic whiteboard and transform it into an interactive communication tool. Using a patented process, VividBoard embeds brilliant graphics into a high gloss surface for premium quality and durability.

For more information, visit [vividboard.com](http://vividboard.com) or call 877-543-2999





Nexus IdeaWall (left) with VividBoard custom printed graphic and custom MyHarmony Glassboard (right).

# WADDELL®

a GMi company®

## Display Solutions



For more than a century, craftsmen have been carefully constructing Waddell display cases in the time-honored tradition of Waddell quality. The Waddell brand of display cases has been part of the GMi family of brands since 1986. The difference between a Waddell showcase and others is in the details. This distinctive level of quality can be touched and seen in the solid, well-constructed fit and finish of every case. We combine today's technology and designs with yesterday's personal commitment to constructing the finest U.S.A. made cases available.

For more information, visit [waddellfurniture.com](http://waddellfurniture.com) or call 800.622.1331

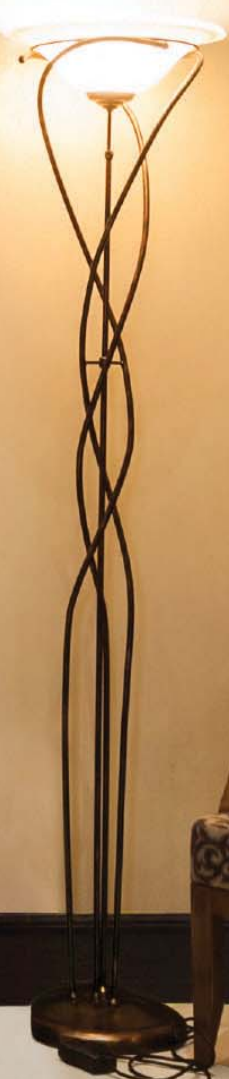

Vantage Display Case.



Communicate. Collaborate. Learn.

[www.ghent.com](http://www.ghent.com)

GH-catalog-02-2017