

# FLORENCE CORPORATION

Call Florence Today Toll-free

800.275.1747

Visit Us Online for More Info

[FlorenceMailboxes.com](http://FlorenceMailboxes.com)



2017 Full Line Product Catalog

## Centralized Mailbox Products & Storage Solutions





# Florence Corporation

*Established. Dependable. Strong.*

Like all great stories, ours started in a garage. Elbow grease, a sweaty brow. It's that kind of story.

More than 80 years later, we're still hard at it; continually perfecting our craft, allowing you to perfect yours.

You may take our products for granted. We take that as a compliment. Our products don't require attention or fuss. They're built smart, designed to work, and engineered to last.

We empower our customers with the products, the support, and the tools to design faster. Build smarter. Manage better.

We understand that in a world of global commerce, demands of efficiency and those last minute deadlines, you need a partner that can keep pace.

You've met your match with Florence. Established. Dependable. Strong. It's not just what we make...it's what makes us.





## Powering Your Centralized Mailbox Design Since 1934

Florence has been the innovator in centralized mail delivery equipment from the beginning. Since our first mailbox patent in 1934, we have grown our product lines to provide the best solutions for both design professionals and postal officials throughout ever changing times.

Our portfolio of products cover centralized mail delivery applications for many different architectural styles; providing both standard pre-configured and custom configurable options in various powdercoat color finishes, as well as storage solutions for either standalone or complementary solutions.

We are also the only manufacturer authorized to supply cluster box units, outdoor parcel lockers, replacement pedestals and parts directly to the U.S. Postal Service since they awarded Florence Corporation their single-source contract for outdoor delivery equipment in 2005. And, over the last 14 years, Florence has been honored to have been awarded two different single-source equipment



contracts and six different supplier awards from the U.S. Postal Service.

With a nationwide network of Authorized Florence Dealers, you have local access to our knowledgeable product experts who can also help you navigate local codes and accessibility requirements, as well as postal regulations for your new construction or remodel project.

Whether you want to do-it-yourself or prefer to have someone help you every step of the way, Florence has a solution just for you!



# Table of Contents

## Product Line Overview

### Cluster Box Units and Accessories



Section Overview	6
Features and Options	8
Cluster Box Units	10
Outdoor Parcel Lockers	10
Decorative Cluster Box Units	11

The most popular USPS Approved centralized mail delivery equipment for residential neighborhoods is the free-standing, pedestal-mounted Cluster Box Unit (CBU). These units boast locked compartments plus integrated parcel lockers and a secure outgoing slot for convenient mail collection. These pre-configured outdoor units are widely used across North America for safe, secure access to mail and package delivery 24 hours a day by multiple residents in one central location. They can be grouped together at the entrance of a gated community or spread throughout the neighborhood as designated by the USPS.

### STD-4C Mailboxes and Accessories



Section Overview	12
Features and Options	16
versatile™ 4C Mailbox Suites	17
4C Mailbox Enclosures	33
4C Pedestal Mount Mailboxes	34

STD-4C mailboxes are now specified by the USPS for all new multi-family construction. Florence is proud to have been the first manufacturer to introduce a full USPS Approved line of 4C mailboxes. This robust product line provides a simple, easy-to-use 'pre-configured' line of mailbox and parcel locker modules which all meet or exceed every security requirement as outlined in the USPS STD-4C regulation for wall-mounted mail receptacles. This indoor/outdoor product is architecturally specified and can easily be added to any design through BIM Objects or the Florence online Revit mailbox configurator.



## Replacement Mailboxes



Section Overview	36
Postal Delivery-Horizontal	38
Postal Delivery-Custom	40
Private Delivery-Horizontal	42
Private Delivery-Custom	46
Postal Delivery-Vertical	50

Florence has been designing and manufacturing mailboxes for centralized delivery since 1934 and is proud to continue building its horizontal and vertical mailboxes for your postal replacement and private delivery applications.

## Mailbox Accessories



Key Keepers / Directories	50
Letter Boxes / Drops	51
Collection Boxes	52

## Mini Storage Lockers



Features and Options	56
Dims and Options	57

## Additional Resources

Centralized Mail Delivery	58
---------------------------	----

Product Support	60
-----------------	----





# Cluster Box Units

## *Securely Handling Mail and Packages*



Whether your neighborhood has aging mailboxes or if you are just tired of the snowplow knocking over your curb-side mailbox, secure and convenient cluster box units may be the solution.

Developed and approved by the USPS in 2005, the new cluster box unit "F" specification became the standard for all manufacturers and replaces both the outdated Neighborhood Delivery Collection Box Unit (NDCBU) and the "E" series CBU. No longer permitted for replacement or new installations, the original NDCBU introduced convenience for residents and letter carriers alike, but unfortunately these units are now falling into disrepair as they have aged, and are in many

cases, quite dilapidated. The newer specifications and thoroughly tested design requires more stringent security features which help protect your valuable mail and parcels better than any previously available community mailbox. (see *images on opposite page.*)

As these older units may have been in your community for well over 20 years, it is the Homeowners Association (or simply the residents of the neighborhood) responsibility to maintain the mailbox. Newer units have larger compartments which lay the mail flat rather than rolling it, built in parcel lockers, convenient outgoing mail slots, and are significantly more secure.





With up to 16 locked compartments, plus up to four integrated parcel lockers, and a secure outgoing slot convenient for mail collection, pre-configured CBU equipment is the perfect solution for your neighborhood. These pedestal-mounted units are widely used across North America for safe, secure access to mail and package delivery 24 hours a day by multiple residents in one central location.

Plus, continued growth in online shopping means providing ample parcel locker space for package delivery is more important than ever! Expand your

residents' ability to securely receive packages by adding matching outdoor parcel lockers (OPL) to your new or existing centralized mail delivery installation, or create a standalone package center. Florence is proud to be the **only** USPS Approved manufacturer of the OPL, ensuring the Postal Service can always deliver the packages you or your customers are waiting for the very first time! *(see page 10 for product details)*

Dress up your basic CBU with decorative accessories in two distinct styles to fit your neighborhood. *(see page 11 for product details.)*



**Obsolete** NDCBUs are no longer permitted for replacement or new installations.



**New** CBUs accommodate both mail and packages while providing greater security.



# Cluster Box Units

## Features and Options



Florence "F" Series CBU is Officially Licensed by the US Postal Service

The complete Florence vital™ 1570 series CBU line was the first Officially Licensed CBU product of the US Postal Service for centralized mail delivery. License #1CDSEQ-08-B-0012



Whether you plan to serve four or 2,000 residents, cluster box units (CBU) provide a flexible solution to accommodate your building project needs. Simply select the pre-configured unit(s) that has the best options for your residents. These standard units can be used individually or in larger group installations - all providing a convenient, secure method of mail and package delivery to residents.

 [florencemailboxes.com/CBU](http://florencemailboxes.com/CBU)

## Cluster Box Unit Standard Compartment Sizes

All CBU Types are USPS Approved and pre-configured with standard tenant and parcel locker compartment heights which meet specific regulations.

Note: All OPL parcel locker compartments are 19-5/8" H x 12" W

Type I, II, III, VI  
Tenant Compartment  
3" H x 12" W



Type IV  
Tenant Compartment  
4-3/4" H x 12" W



Type V  
Double High Tenant Compartment  
6-1/2" H x 12" W

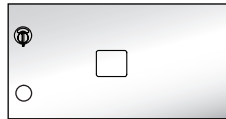

Type I, II, III, IV, V, VI  
Parcel Locker Compartment  
9-7/8" H x 12" W

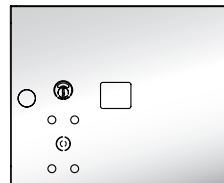

Type I, III, V, VI  
Parcel Locker Compartment  
13-3/8" H x 12" W

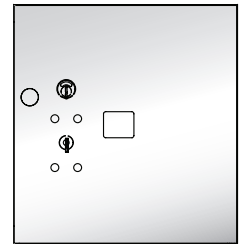

(Actual Size Shown)

## Door ID Options

**Decals:** All CBUs come standard with silver adhesive decals which are 1-1/2"H x 1-3/4"W. Black lettering can contain up to five characters per decal.

**Engraving:** Custom engraving utilizes the USPS Standard *US Block* font and is 3/4" tall. All engraving can include up to 12 characters per line.



(Optional Engraving into Aluminum Door)

## Color Options

All cluster box unit types are available in four different architectural color options; all in a durable, powder coat finish.

\*Note: Postal Grey is USPS Approved for replacement only and is not intended for new installations.



Black (BK)



Dark Bronze (DB)



Sandstone (SD)



Postal Grey\* (PG)

# Cluster Boxes

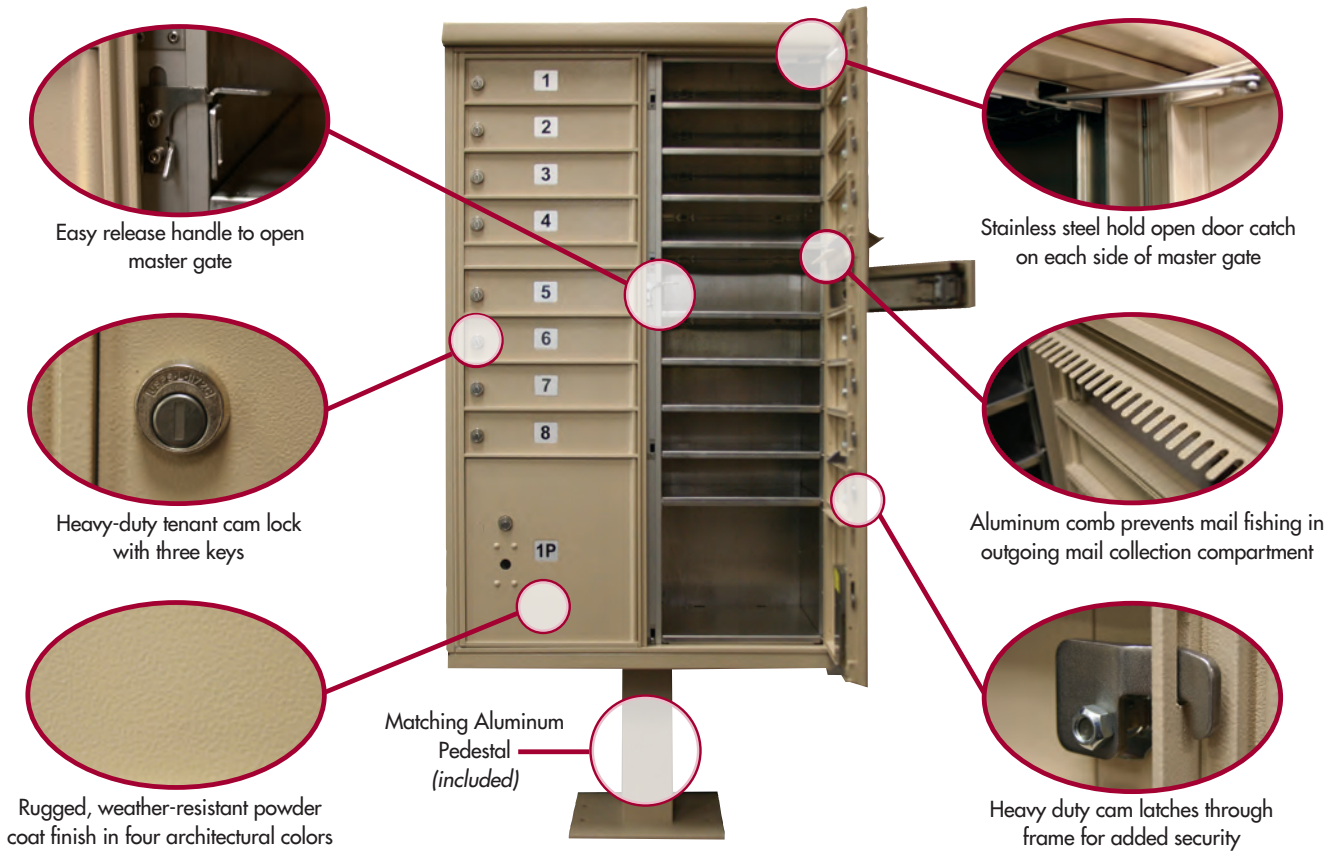
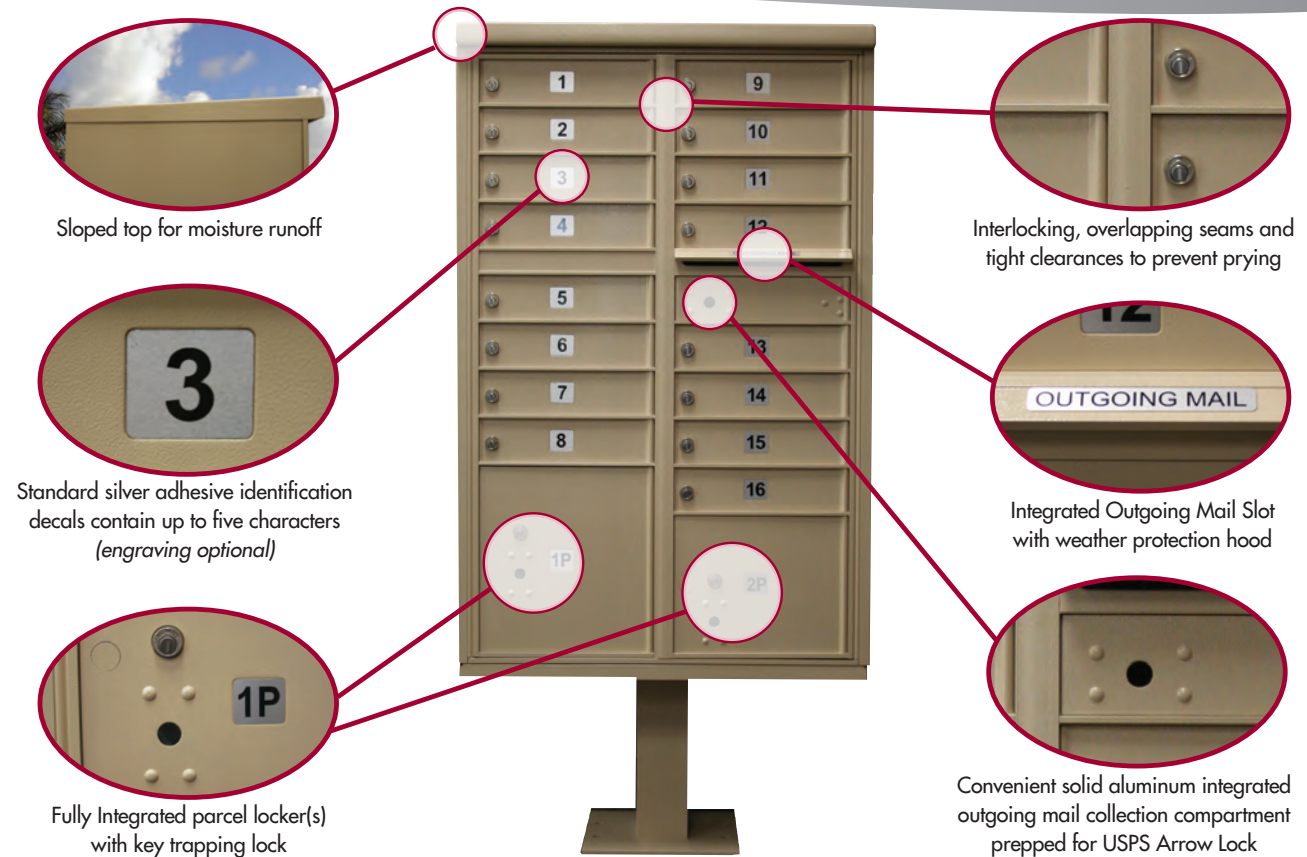





## Outdoor Delivery Equipment

Florence is proud to partner with end-users, design, construction and building professionals, and postal officials alike to continually develop new products which meet the ever-changing project demands and USPS Centralized Mail Delivery requirements.



### vital™ cluster box units

Pre-configured units include built-in parcel lockers and outgoing mail collection for added convenience to be used alone or in large groupings to accommodate every project need.

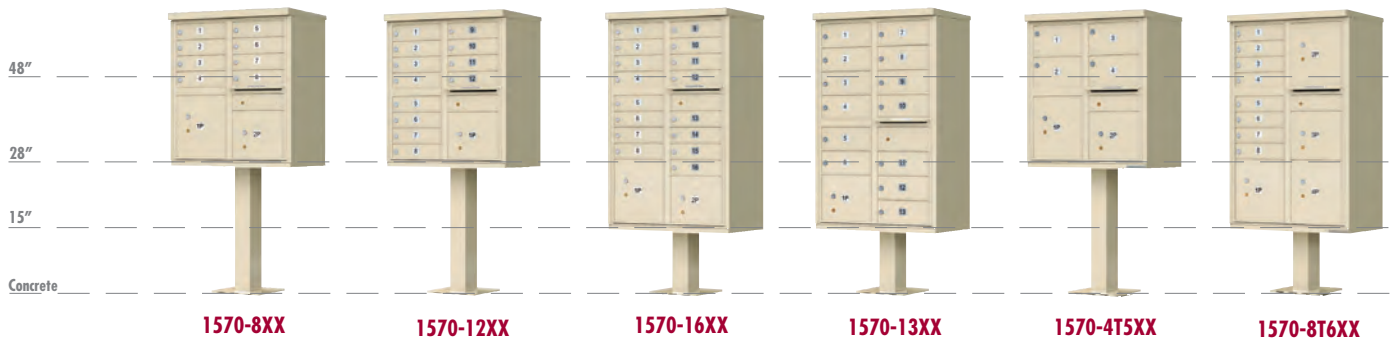

MODEL #	CBU TYPE	INSTALLED HEIGHT	INSTALLED WIDTH	INSTALLED DEPTH	PEDESTAL HEIGHT	WEIGHT (LBS)	STANDARD TENANT COMPARTMENT DIMENSIONS	MAILBOX COMPARTMENTS	PARCEL LOCKERS
1570-8XX	vital™ Type I CBU	62"	30-1/2"	18"	28-1/2"	144	3"H x 12"W x 15"D	8	2
1570-12XX	vital™ Type II CBU	62"	30-1/2"	18"	28-1/2"	144	3"H x 12"W x 15"D	12	1
1570-16XX	vital™ Type III CBU	62"	30-1/2"	18"	14-1/2"	175	3"H x 12"W x 15"D	16	2
1570-13XX	vital™ Type IV CBU	62"	30-1/2"	18"	14-1/2"	167	4-3/4"H x 12"W x 15"D	13	1
1570-4T5XX	vital™ Type V CBU	62"	30-1/2"	18"	28-1/2"	145	6-1/2"H x 12"W x 15"D	4	2
1570-8T6XX	vital™ Type VI CBU	62"	30-1/2"	18"	14-1/2"	176	3"H x 12"W x 15"D	8	4

Note: Exchange "XX" in Model # above for two-digit color reference: Black=BK Dark Bronze=DB Sandstone=SD Postal Grey=PG

### valiant™ outdoor parcel lockers

Industry unique package delivery system with key trapping locks can be used alone or with CBU installation to increase convenience for your residents.



#### Sole Source Supplier:

Florence Manufacturing continues to dedicate itself to providing secure postal specialty products built to the latest USPS Standards. We are the *only* manufacturer authorized to supply cluster box units, outdoor parcel lockers, replacement pedestals, and parts directly to the USPS since they awarded Florence their single-source contract for outdoor delivery equipment in 2005. *Florence is also the only company in the industry approved to manufacture outdoor parcel lockers.*



MODEL #	OPL TYPE	INSTALLED HEIGHT	INSTALLED WIDTH	INSTALLED DEPTH	PEDESTAL HEIGHT	WEIGHT (LBS)	STANDARD PARCEL COMPARTMENT DIMENSIONS	MAILBOX COMPARTMENTS	PARCEL LOCKERS
1590-T1XX	valiant™ Type I OPL	62"	16"	18"	14-1/2"	100	19-5/8"H x 12"W x 15"D	0	2
1590-T2XX	valiant™ Type II OPL	62"	30-1/2"	18"	14-1/2"	139	19-5/8"H x 12"W x 15"D	0	4

Note: Exchange "XX" in Model # above for two-digit color reference: Black=BK Dark Bronze=DB Sandstone=SD Postal Grey=PG

## vogue™ cluster box accessories

These fashionable snap-together accessories place the final touches on your centralized neighborhood mailbox; choose from Classic or Traditional style to fit your surrounding area.

Classic



1570-8VXX

1570-12VXX

1570-16VXX

1570-13VXX

1570-4T5VXX

1570-8T6VXX

1590-T1VXX

1590-T2VXX

Traditional



1570-8V2XX

1570-12V2XX

1570-16V2XX

1570-13V2XX

1570-4T5V2XX

1570-8T6V2XX

1590-T1V2XX

1590-T2V2XX

MODEL #	CBU/VOGUE COMBO TYPE	INSTALLED HEIGHT	INSTALLED WIDTH	INSTALLED DEPTH	WEIGHT (LBS)	STANDARD TENANT COMPARTMENT DIMENSIONS	MAILBOX COMPARTMENTS	PARCEL LOCKERS
1570-8VXX	Classic Type I CBU Combo	65-1/8"	33-7/8"	21-3/8"	182	3"H x 12"W x 15"D	8	2
1570-12VXX	Classic Type II CBU Combo	65-1/8"	33-7/8"	21-3/8"	182	3"H x 12"W x 15"D	12	1
1570-16VXX	Classic Type III CBU Combo	65-1/8"	33-7/8"	21-3/8"	206	3"H x 12"W x 15"D	16	2
1570-13VXX	Classic Type IV CBU Combo	65-1/8"	33-7/8"	21-3/8"	198	4-3/4"H x 12"W x 15"D	13	1
1570-4T5VXX	Classic Type V CBU Combo	65-1/8"	33-7/8"	21-3/8"	183	6-1/2"H x 12"W x 15"D	4	2
1570-8T6VXX	Classic Type VI CBU Combo	65-1/8"	33-7/8"	21-3/8"	207	3"H x 12"W x 15"D	8	4
1590-T1VXX	Classic Type I OPL Combo	65-1/8"	19-5/8"	21-3/8"	124	N/A	0	2
1590-T2VXX	Classic Type II OPL Combo	65-1/8"	33-7/8"	21-3/8"	182	N/A	0	4
1570-8V2XX	Traditional Type I CBU Combo	71-3/8"	31-5/8"	18-1/2"	177	3"H x 12"W x 15"D	8	2
1570-12V2XX	Traditional Type II CBU Combo	71-3/8"	31-5/8"	18-1/2"	177	3"H x 12"W x 15"D	12	1
1570-16V2XX	Traditional Type III CBU Combo	71-3/8"	31-5/8"	18-1/2"	203	3"H x 12"W x 15"D	16	2
1570-13V2XX	Traditional Type IV CBU Combo	71-3/8"	31-5/8"	18-1/2"	195	4-3/4"H x 12"W x 15"D	13	1
1570-4T5V2XX	Traditional Type V CBU Combo	71-3/8"	31-5/8"	18-1/2"	178	6-1/2"H x 12"W x 15"D	4	2
1570-8T6V2XX	Traditional Type VI CBU Combo	71-3/8"	31-5/8"	18-1/2"	204	3"H x 12"W x 15"D	8	4
1590-T1V2XX	Traditional Type I OPL Combo	71-3/8"	17-3/8"	18-1/2"	119	N/A	0	2
1590-T2V2XX	Traditional Type II OPL Combo	71-3/8"	31-5/8"	18-1/2"	178	N/A	0	4

Note: Exchange "XX" in Model # above for two-digit color reference: Black=BK Dark Bronze=DB Sandstone=SD Postal Grey=PG



Dress up your outdoor delivery equipment with color coordinating designer caps and pedestal covers in two different styles.





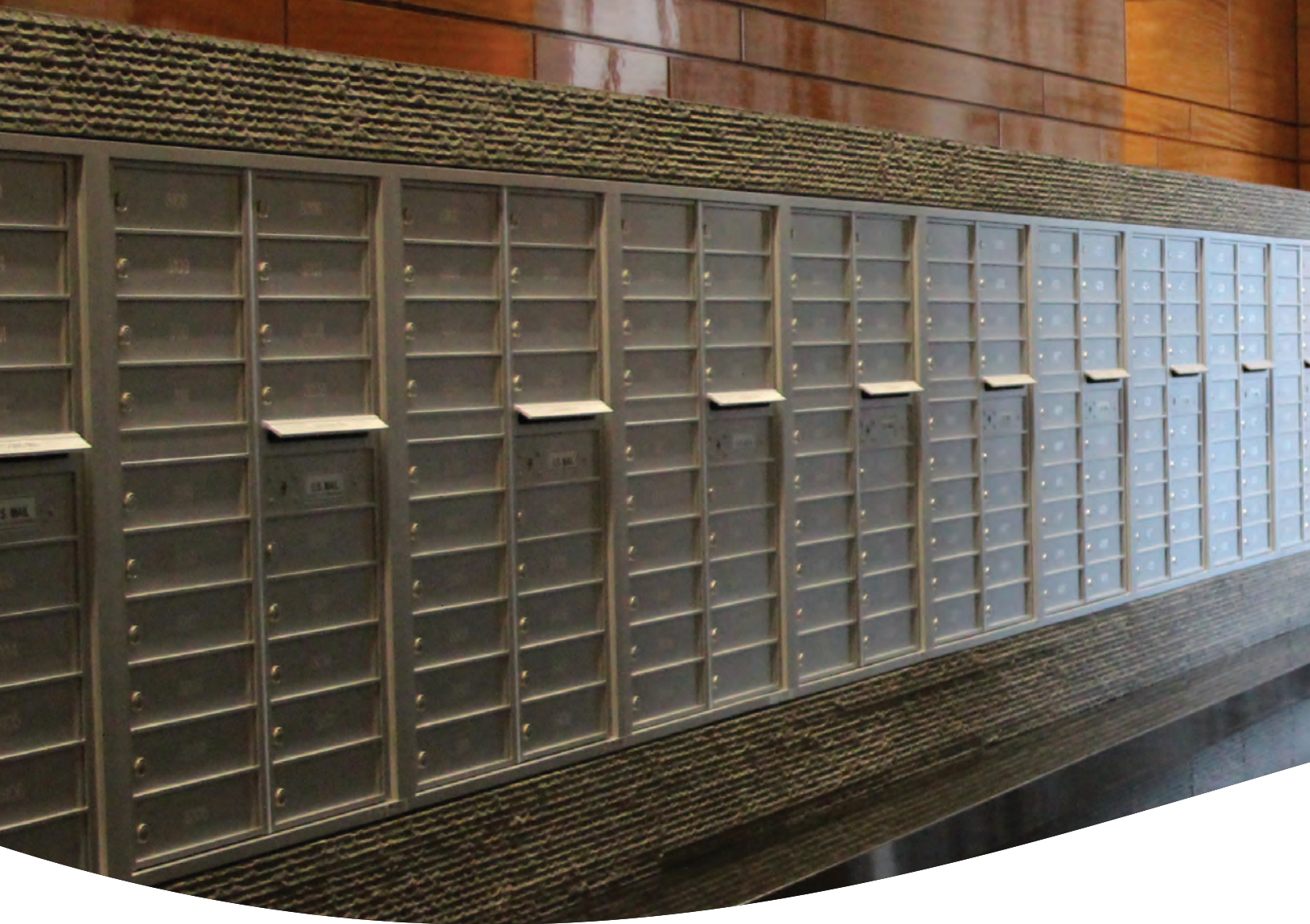

# STD-4C Mailbox Suites

## *The Key to Good Design*



The US Postal Service Operations Manual provides the USPS with autonomy in determining the appropriate mode of delivery; which includes the location and type of equipment to be used. For multi-family new construction, that is most often the STD-4C mailbox.

As the first manufacturer to introduce a full USPS Approved line of mailboxes which met the mandatory USPS wall-mounted mailbox standard (STD) in 2006, Florence has continued to evolve the product line in order to keep pace with changing marketplace demands.

Our robust versatile™ 4C mailbox line was developed with a simple to use modular system that provides a very flexible solution for your individual project needs - taking the guesswork out of meeting the necessary USPS requirements and/or ADA Fair Housing requirements, too.

As an architecturally specified product, Florence takes the guesswork out of the process by providing standard pre-configured options for simple installations, or gives you the ability to custom-build a solution which will make your centralized mail center stand out from all the rest.





Florence is also pleased to offer you numerous industry exclusive standard features, finishes, and accessories; all providing greater design flexibility and installation solutions than any other STD-4C mail equipment available on the market today.

So, whether you are replacing an outdated mailbox installation, or starting a new construction project, Florence stands ready to assist you. Visit us online for simple-to-use resources that allow you to plan your own mailbox installation, view technical and installation information, and learn how to easily customize your project.



These rugged 4C mailboxes are weather-resistant and can be used indoors or out.

Or, contact an Authorized Florence Dealer for personalized assistance. These knowledgeable experts can help you find the right product for your needs, navigate local codes and accessibility, and some even help with installation work.

For architects, we offer robust BIM Objects and an industry unique online Revit Configurator, which allows you to create your own solution and export it as an RFA file for easy download into your existing design. Be sure to check out our 'how-to' video library, online resource toolkit, and take one of several continuing education courses for AIA credit.



Surface-mounted 4C mailboxes are perfect for limited wall depth projects.



# versatile™ 4C Mailboxes

*Flexibility without the fuss*



Florence versatile™ 4C mailboxes provide a simple, easy-to-use 'pre-configured' line of mailboxes and parcel lockers which all meet or exceed every security requirement of the USPS STD-4C regulation for wall-mounted mail receptacles. By providing different "suite" height options, adding the right module to your installation is quick and easy.

Offering over 140 different individual modules to select from, PLUS the ability to configure any base module, Florence has the most robust line of USPS Approved 4C products and installation accessories on the market today.



[florencemailboxes.com/4C](http://florencemailboxes.com/4C)

## Product Design and Security Features

- Standard pre-configured modules with integrated parcel lockers in 12 different heights (*as shown below*)
- Thick, reinforced collection door to prevent break-ins
- Master front-loading door has interlocking, overlapping seams to prevent prying
- Integrated outgoing mail collection compartment with weather protection hood and anti-fishing comb
- One piece extruded hinge to prevent prying
- Solid aluminum frame protects adjacent customer/collection compartments
- Multi-unit connector kit hardware supplied with every module for easier installation across larger openings
- Hardy stainless steel latching hook cam on every tenant door with EXCLUSIVE double-latching cam on all oversized doors
- EXCLUSIVE double-latching parcel locking mechanism design for added door security and strength

**FLORENCE**  
EXCLUSIVE PRODUCT 



# STD-4C Mailboxes

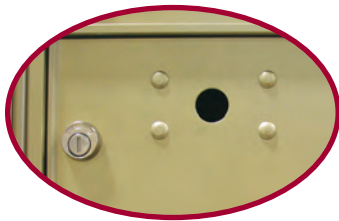

Fully Integrated parcel locker(s) with key trapping lock

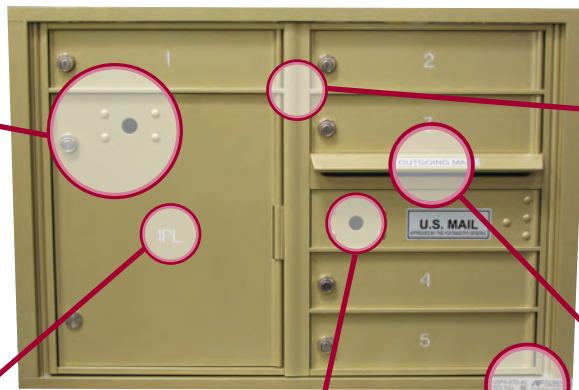

Interlocking, overlapping seams to prevent prying



Standard decals or 3/4" H engraving



Solid aluminum integrated outgoing mail collection compartment prepared for USPS installed Arrow Lock



Integrated Outgoing Mail Slot with weather protection hood



Heavy duty tenant cam lock with three keys

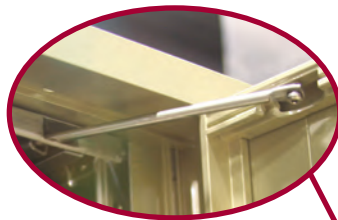

Stainless steel hold open door catch on each side of master gate



Product and manufacturer ID serial tag



Easy release handle to open master gate



Aluminum comb prevents mail fishing in outgoing mail collection compartment

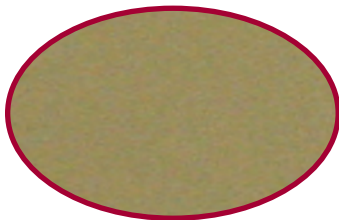

Rugged, weather-resistant powder coat finish



Heavy duty cam latches through frame for added security





# versatile™ 4C Mailboxes

## Plenty of Choices



The Florence versatile™ 4C mailbox line provides unsurpassed flexibility in creating your perfect centralized mail delivery center with nearly a limitless combination of options.

Begin by selecting the mailbox height and module for your needs (see module pages 18-29), choose master loading type, color, ID, and lock selections, and finally the manner in which it will be mounted.

## Module Choices

### USPS and Private STD-4C Mailboxes

Over 120 individual mailbox modules are available, all of which can be customized with oversized doors and lock options for both postal and private delivery applications.



### Collection Boxes

These secure modules complement your mailbox installation and are designed for all your collection needs; postal or private collection, x-rays, DVD/Blue Ray, books, etc.



### Recycling Bins

Keep the centralized mail center tidy by providing receptacles for the disposal of unwanted mail, or create a recycling center with these industry exclusive matching modules.

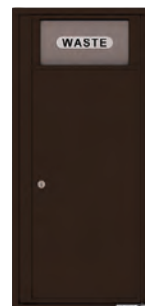

(Actual Size Shown)

## Door ID Options

**Decals:** All 4Cs come standard with silver adhesive decals which are 1-1/2"H x 1-3/4"W. Black lettering can contain up to five characters per decal.

**Engraving:** Custom engraving utilizes the USPS Standard US Block font and is 3/4" tall. All engraving can include up to 12 characters per line, up to two lines per door.



(Optional Engraving into Aluminum Door)

## Color Options

Customize your versatile™ 4C module with one of eight different architectural color options, all in a durable, powder coat finish.

Colors shown are representative of the actual powder coat finish but are limited by printing conditions and may vary slightly from finished product.



# versatile™ 4C Mailboxes

## Florence 4C Quick Reference Guide



All STD-4C compliant mailboxes must meet the U.S. Postal Service's (USPS) design and installation regulation in order to receive the designation *USPS Approved*. Accessibility regulations may vary locally and regionally; always consult local building codes for applicable accessibility requirements related to your mailbox project. (See page 30 for additional details.)

Sequential numbering (rather than assigning mailbox IDs that match apartment or house numbers) of mailbox compartments may allow greater flexibility in providing accessible mailbox compartments that meet accessibility regulations applicable to your project. It also provides greater security and privacy for residents.

Mounting at specified heights AFF (Above Finished Floor) ensure USPS installation requirements are met.

- If your installation is for USPS delivery and contains any tenant compartments in the bottom row, the minimum height from the floor is 28"
- If your installation contains no tenant compartments in the bottom row, you have the option to install at a minimum of 15" from the floor to be compliant with ADA and USPS requirements.

### versatile™ 4C Mailbox Height Options

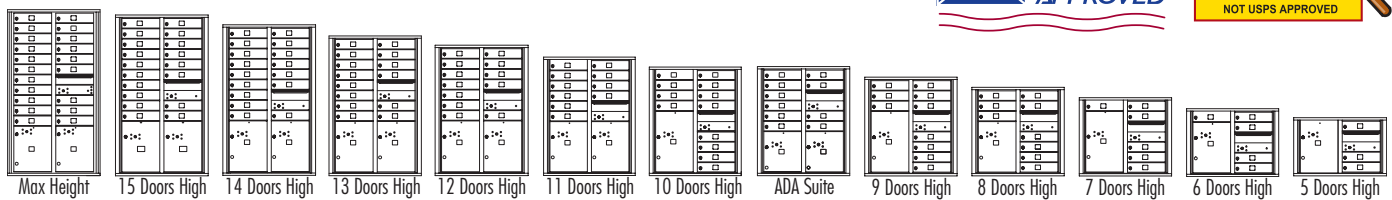

The reference module images and charts on the following pages show the proper installation heights for Florence's versatile™ 4C mailbox suites to help your project comply with USPS installation and accessibility codes. Drawings shown are for your quick reference only. For specific standards, consult with local authorities.



### Standard Lock

Cam-lock is USPS Approved and standard on all versatile™ 4C mailboxes.



K91910

### Top/Side Views For All Heights

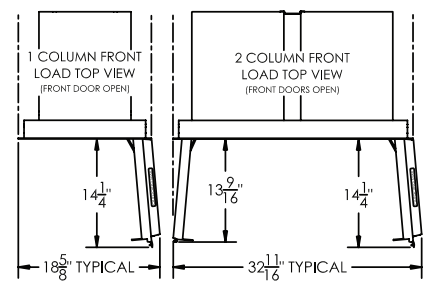
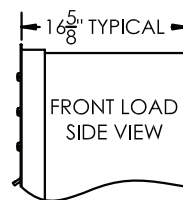



## MAX HEIGHT SUITE Actual: 56-1/2"H x 31-9/16"W (Double) or 17-1/2"W (Single) x 17"D / Rough Opening: 55-9/16"H x 30-5/16"W (Double) or 16-1/4"W (Single) x 17"D

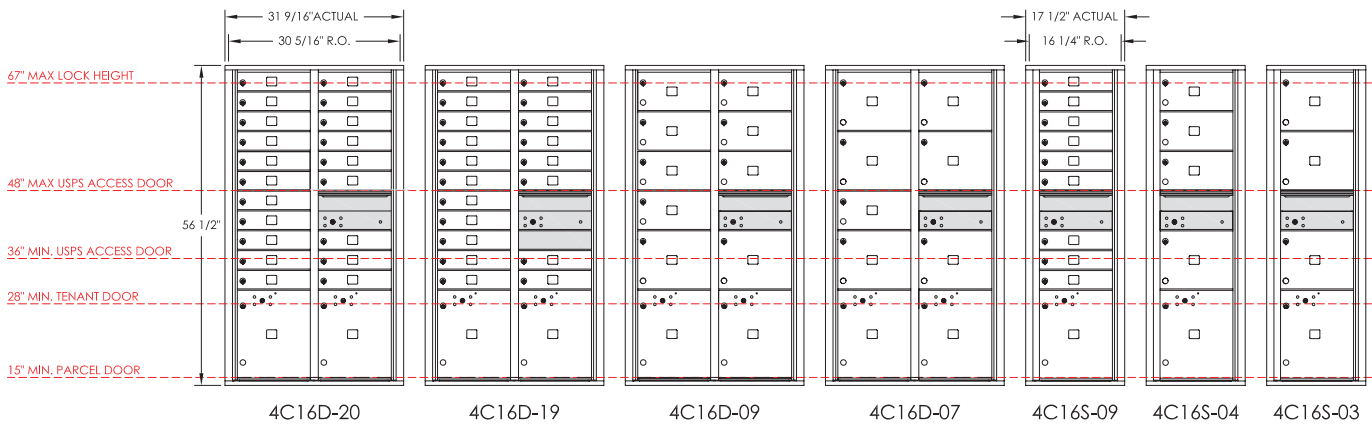

Floor

Model (Compartment Types)	4C16D-20 (20 MB1, 2 PL15)	4C16D-19 (19 MB1, 2 PL15)	4C16D-09 (7 MB2, 2 MB3, 2 PL15)	4C16D-07 (1 MB2, 6 MB3, 2 PL15)	4C16S-09 (9 MB1, 1 PL15)	4C16S-04 (3 MB2, 1 MB3, 1 PL15)	4C16S-03 (3 MB3, 1 PL15)
# Mailboxes (Total)	20	19	9	7	9	4	3
# Parcel Lockers (Total)	2	2	2	2	1	1	1
# Collection	1	1	1	1	1	1	1
# BINS	0	0	0	0	0	0	0
# Mailboxes Under 48"	8	7	3	3	3	1	1
Module Weight (lbs)	171	163	157	140	97	81	62

## 15 DOORS HIGH Actual: 54-3/4"H x 31-9/16"W (Double) or 17-1/2"W (Single) x 17"D / Rough Opening: 53-13/16"H x 30-5/16"W (Double) or 16-1/4"W (Single) x 17"D

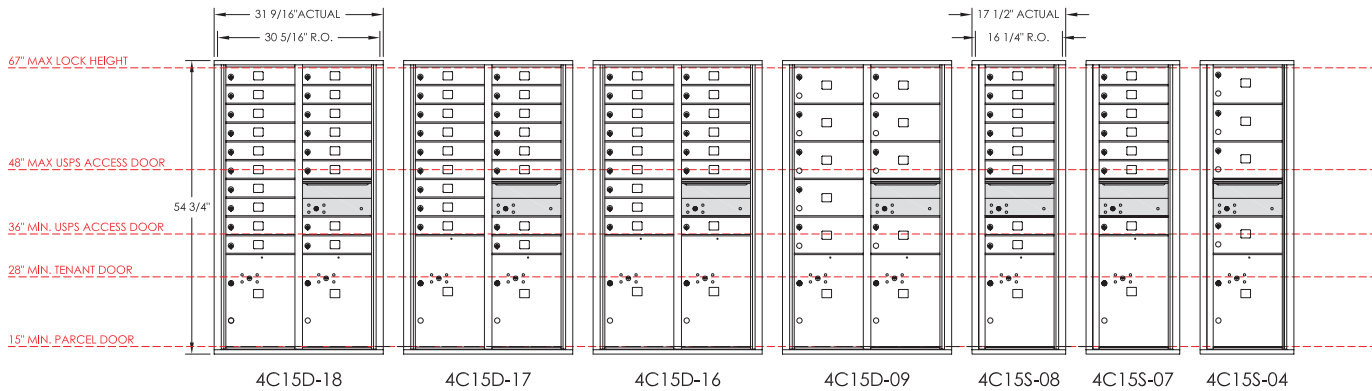

Floor

Model (Compartment Types)	4C15D-18 (18 MB1, 2 PL5)	4C15D-17 (17 MB1, 1 PL5, 1 PL6)	4C15D-16 (16 MB1, 2 PL6)	4C15D-09 (9 MB2, 2 PL5)	4C15S-08 (8 MB1, 1 PL5)	4C15S-07 (7 MB1, 1 PL6)	4C15S-04 (4 MB2, 1 PL5)
# Mailboxes (Total)	18	17	16	9	8	7	4
# Parcel Lockers (Total)	2	2	2	2	1	1	1
# Collection	1	1	1	1	1	1	1
# BINS	0	0	0	0	0	0	0
# Mailboxes Under 48"	8	7	6	3	3	2	1
Module Weight (lbs)	160	158	156	144	87	85	79

### NOTES:

All standard 4C mailbox modules shown above are fully configurable; visit [florencemailboxes.com/configure](http://florencemailboxes.com/configure) to quickly and easily create your custom solution.

See page 31 for mailbox (MB) and parcel locker (PL) compartment size definitions and configurable options.

Modules noted with an asterisk (\*) do not meet USPS installation specifications and are for private delivery.

All model numbers listed are for front-load modules; add -P for Pedestal-mount modules at the end of the number; see page 34 for additional details.

Actual: 56-1/2"H x 31-9/16"W (Double) or 17-1/2"W (Single) x 17"D / Rough Opening: 55-9/16"H x 30-5/16"W (Double) or 16-1/4"W (Single) x 17"D **MAX HEIGHT SUITE**

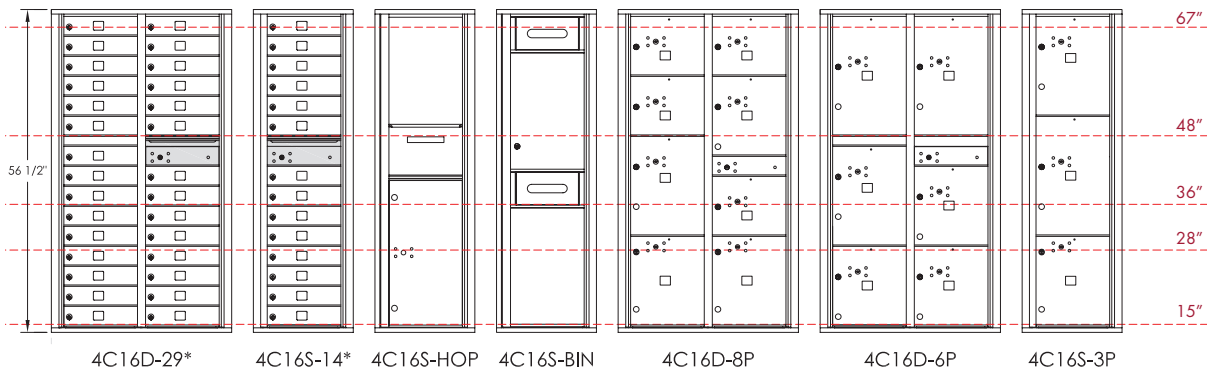

4C16D-29* (29 MB1)	4C16S-14* (14 MB1)	4C16S-HOP	4C16S-BIN	4C16D-8P (4 PL3, 1 PL4, 1 PL5, 2 PL15)	4C16D-6P (3 PL4, 1 PL5, 2 PL6)	4C16S-3P (1 PL15, 1 PL5, 1 PL6)	Model (Compartment Types)
29	14	0	0	0	0	0	# Mailboxes
0	0	0	0	8	6	3	# Parcel Lockers
1	1	1	0	0	0	0	# Collection
0	0	0	2	0	0	0	# BINS
17	8	0	0	0	0	0	# MB under 48"
170	96	76	65	113	105	58	Module Weight

Actual: 54-3/4"H x 31-9/16"W (Double) or 17-1/2"W (Single) x 17"D / Rough Opening: 53-13/16"H x 30-5/16"W (Double) or 16-1/4"W (Single) x 17"D **15 DOORS HIGH**

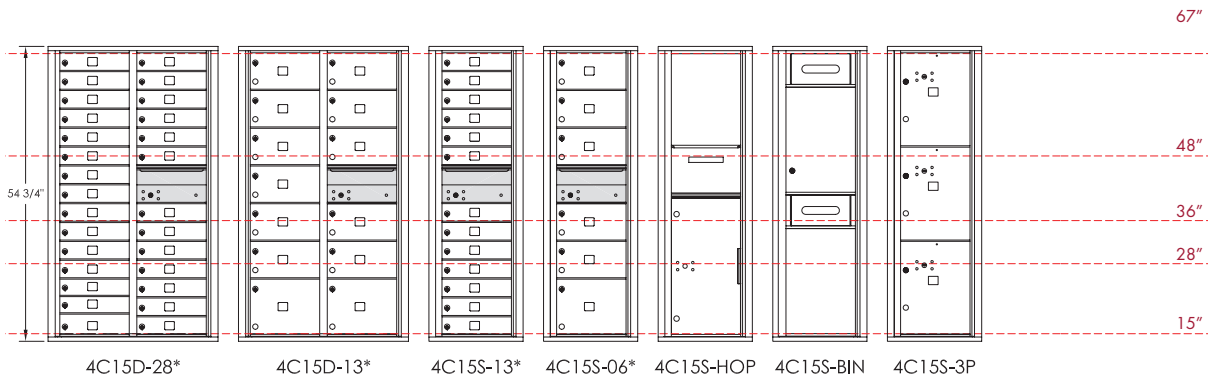

4C15D-28* (28 MB1)	4C15D-13* (11 MB2, 2 MB3)	4C15S-13* (13 MB1)	4C15S-06* (5 MB2, 1 MB3)	4C15S-HOP	4C15S-BIN	4C15S-3P (3 PL5)	Model (Compartment Types)
28	13	13	6	0	0	0	# Mailboxes
0	0	0	0	0	0	3	# Parcel Lockers
1	1	1	1	1	0	0	# Collection
0	0	0	0	0	2	0	# BINS
18	7	8	3	0	0	0	# MB under 48"
122	142	95	79	74	63	75	Module Weight

**NOTES:**

All standard 4C mailbox modules shown above are fully configurable; visit [florencemailboxes.com/configure](http://florencemailboxes.com/configure) to quickly and easily create your custom solution.

See page 31 for mailbox (MB) and parcel locker (PL) compartment size definitions and configurable options.

Modules noted with an asterisk (\*) do not meet USPS installation specifications and are for private delivery.

All model numbers listed are for front-load modules; add -P for Pedestal-mount modules at the end of the number; see page 34 for additional details.



## 14 DOORS HIGH Actual: 51-1/4"H x 31-9/16"W (Double) or 17-1/2"W (Single) x 17"D / Rough Opening: 50-5/16"H x 30-5/16"W (Double) or 16-1/4"W (Single) x 17"D

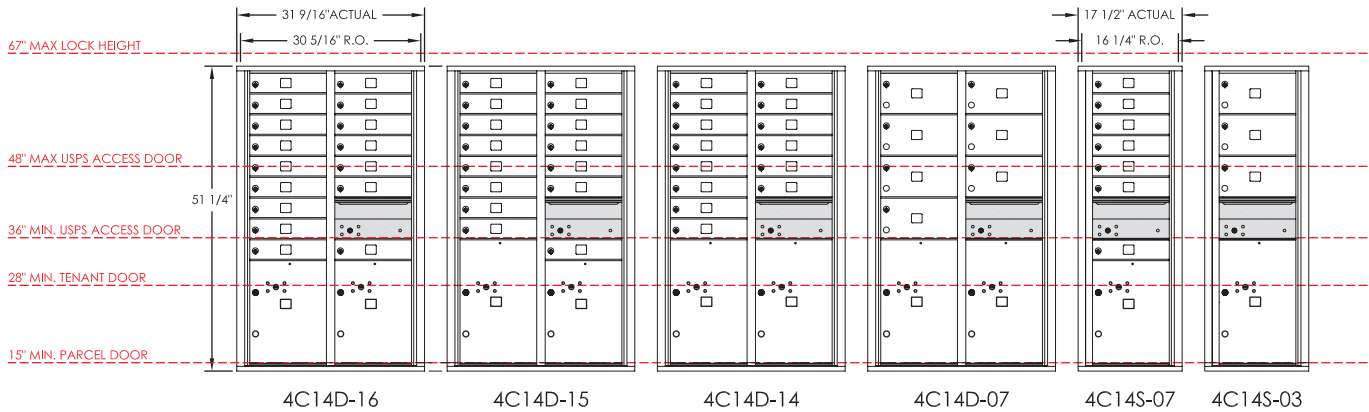

Floor

Model (Compartment Types)	4C14D-16 (16 MB1, 2 PL5)	4C14D-15 (15 MB1, 1 PL5, 1 PL6)	4C14D-14 (14 MB1, 2 PL6)	4C14D-07 (7 MB2, 2 PL6)	4C14S-07 (7 MB1, 1 PL5)	4C14S-03 (3 MB2, 1 PL6)
# Mailboxes (Total)	16	15	14	7	7	3
# Parcel Lockers (Total)	2	2	2	2	1	1
# Collection	1	1	1	1	1	1
# BINS	0	0	0	0	0	0
# Mailboxes Under 48"	8	7	6	3	3	1
Module Weight (lbs)	137	130	109	99	72	56

## 13 DOORS HIGH Actual: 47-3/4"H x 31-9/16"W (Double) or 17-1/2"W (Single) x 17"D / Rough Opening: 46-13/16"H x 30-5/16"W (Double) or 16-1/4"W (Single) x 17"D

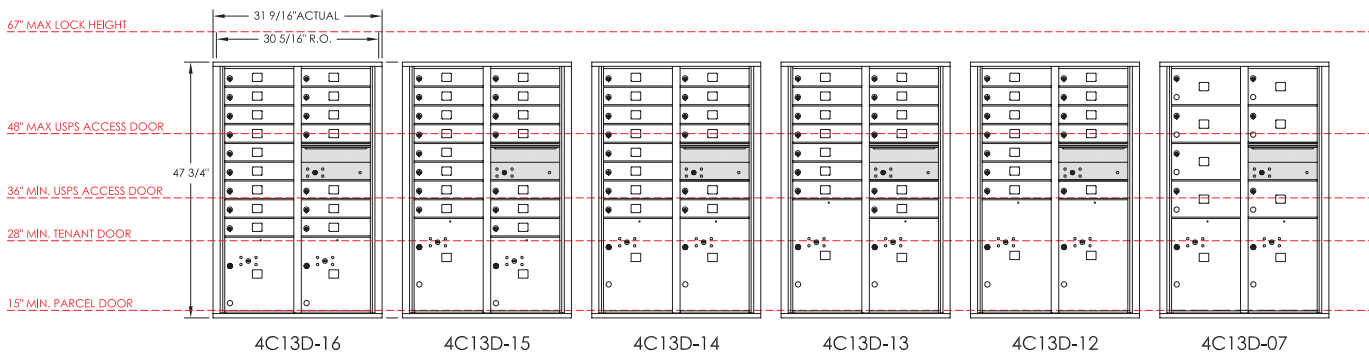

Floor

Model (Compartment Types)	4C13D-16 $\phi$ (16 MB1, 2 PL4)	4C13D-15 (15 MB1, 1 PL4, 1 PL5)	4C13D-14 (14 MB1, 2 PL5)	4C13D-13 (13 MB1, 1 PL5, 1 PL6)	4C13D-12 (12 MB1, 2 PL6)	4C13D-07 (7 MB2, 2 PL5)
# Mailboxes (Total)	16	15	14	13	12	7
# Parcel Lockers (Total)	2	2	2	2	2	2
# Collection	1	1	1	1	1	1
# BINS	0	0	0	0	0	0
# Mailboxes Under 48"	10	9	8	7	6	3
Module Weight (lbs)	129	127	125	123	121	114

### NOTES:

All standard 4C mailbox modules shown above are fully configurable; visit [florencemailboxes.com/configure](http://florencemailboxes.com/configure) to quickly and easily create your custom solution.

See page 31 for mailbox (MB) and parcel locker (PL) compartment size definitions and configurable options.

Modules noted with (\*) do not meet USPS installation specifications and are for private delivery; those noted with ( $\phi$ ) contain PL under the USPS required 15" tall - see page 25 for details.

All model numbers listed are for front-load modules; add -P for Pedestal-mount modules at the end of the number; see page 34 for additional details.

Actual: 51-1/4"H x 31-9/16"W (Double) or 17-1/2"W (Single) x 17"D / Rough Opening: 50-5/16"H x 30-5/16"W (Double) or 16-1/4"W (Single) x 17"D **14 DOORS HIGH**

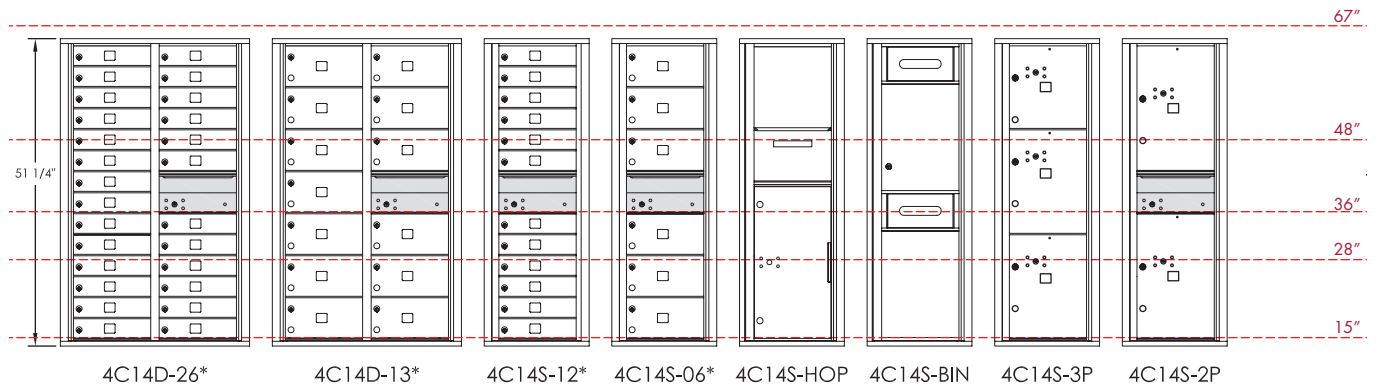

4C14D-26* (26 MB1)	4C14D-13* (13 MB2)	4C14S-12* (12 MB1)	4C14S-06* (6 MB2)	4C14S-HOP	4C14S-BIN	4C14S-3P (1 PL4, 2 PL5)	4C14S-2P (2 PL6)	Model (Compartment Types)
26	13	12	6	0	0	0	0	# Mailboxes
0	0	0	0	0	0	3	2	# Parcel Lockers
1	1	1	1	1	0	0	1	# Collection
0	0	0	0	0	2	0	0	# BINS
18	9	8	4	0	0	0	0	# MB under 48"
145	101	76	56	72	58	56	55	Module Weight

Actual: 47-3/4"H x 31-9/16"W (Double) or 17-1/2"W (Single) x 17"D / Rough Opening: 46-13/16"H x 30-5/16"W (Double) or 16-1/4"W (Single) x 17"D **13 DOORS HIGH**

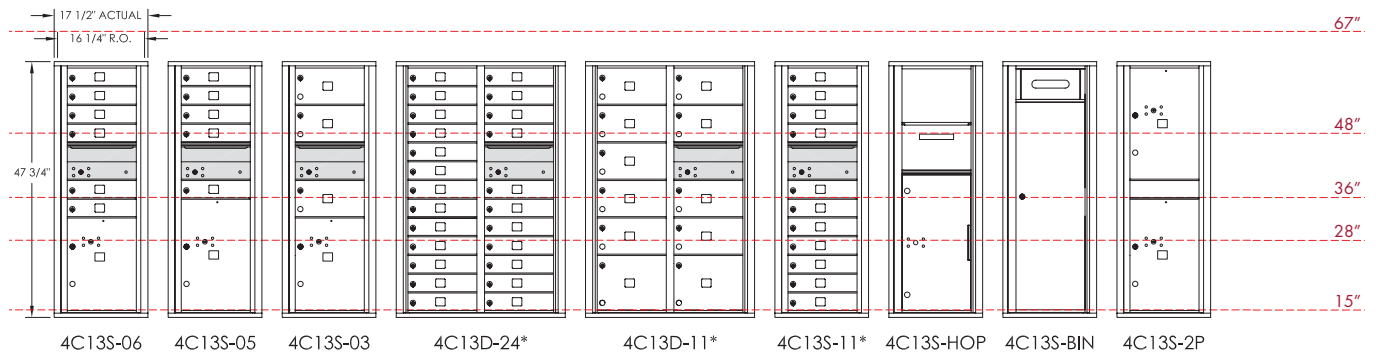

4C13S-06 (6 MB1, 1 PL5)	4C13S-05 (5 MB1, 1 PL6)	4C13S-03 (3 MB2, 1 PL5)	4C13D-24* (24 MB1)	4C13D-11* (9 MB2, 2 MB3)	4C13S-11* (11 MB1)	4C13S-HOP	4C13S-BIN	4C13S-2P (2 PL6)	Model (Compartment Types)
6	5	3	24	11	11	0	0	0	# Mailboxes
1	1	1	0	0	0	0	0	2	# Parcel Lockers
1	1	1	1	1	1	1	0	0	# Collection
0	0	0	0	0	0	0	1	0	# BINS
3	2	1	18	7	8	0	0	0	# MB under 48"
68	67	64	133	112	72	69	45	57	Module Weight

**NOTES:**

All standard 4C mailbox modules shown above are fully configurable; visit [florencemailboxes.com/configure](http://florencemailboxes.com/configure) to quickly and easily create your custom solution.

See page 31 for mailbox (MB) and parcel locker (PL) compartment size definitions and configurable options.

Modules noted with an asterisk (\*) do not meet USPS installation specifications and are for private delivery.

All model numbers listed are for front-load modules; add -P for Pedestal-mount modules at the end of the number; see page 34 for additional details.



## 12 DOORS HIGH Actual: 44-1/4"H x 31-9/16"W (Double) or 17-1/2"W (Single) x 17"D / Rough Opening: 43-5/16"H x 30-5/16"W (Double) or 16-1/4"W (Single) x 17"D

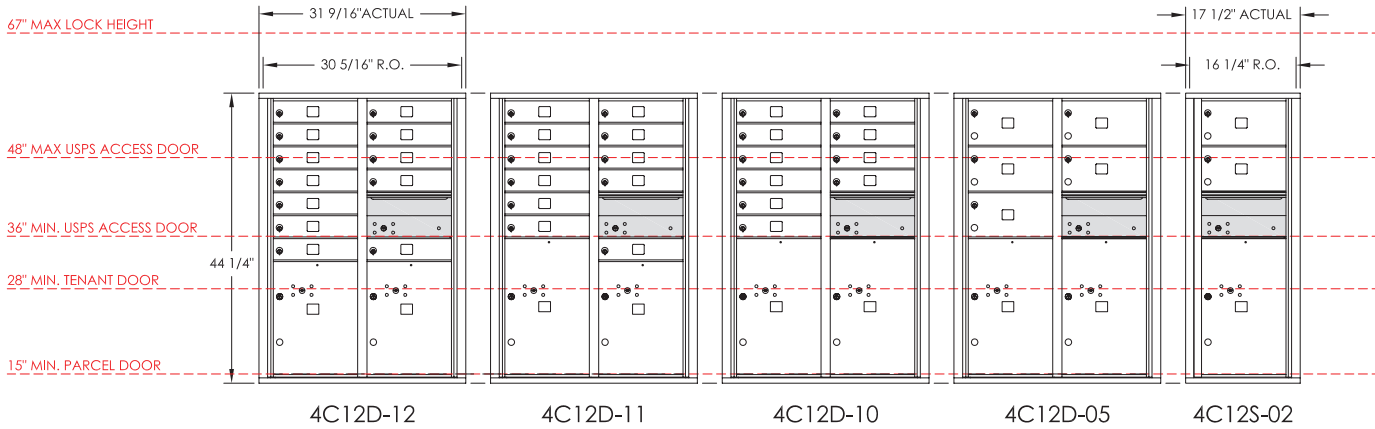

Floor

Model (Compartment Types)	4C12D-12 (12 MB1, 2 PL5)	4C12D-11 (11 MB1, 1 PL5, 1 PL6)	4C12D-10 (10 MB1, 2 PL6)	4C12D-05 (5 MB2, 2 PL6)	4C12S-02 (2 MB2, 1 PL6)
# Mailboxes (Total)	12	11	10	5	2
# Parcel Lockers (Total)	2	2	2	2	1
# Collection	1	1	1	1	1
# BINS	0	0	0	0	0
# Mailboxes Under 48"	8	7	6	3	1
Module Weight (lbs)	116	114	112	104	59

## 11 DOORS HIGH Actual: 40-3/4"H x 31-9/16"W (Double) or 17-1/2"W (Single) x 17"D / Rough Opening: 39-13/16"H x 30-5/16"W (Double) or 16-1/4"W (Single) x 17"D

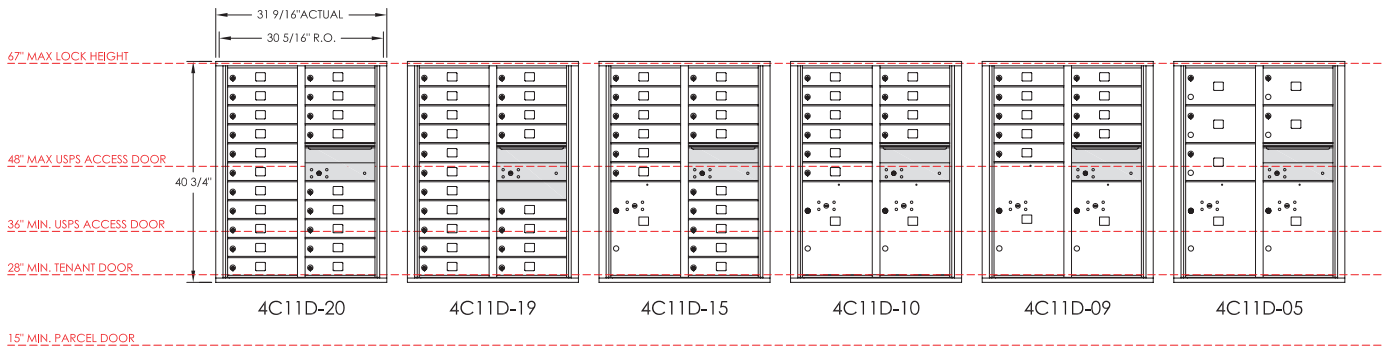

Floor

Model (Compartment Types)	4C11D-20 (20 MB1)	4C11D-19 (19 MB1)	4C11D-15 (15 MB1, 1 PL5)	4C11D-10 (10 MB1, 2 PL5)	4C11D-09 (9 MB1, 1 PL5, 1 PL6)	4C11D-05 (5 MB2, 2 PL5)
# Mailboxes (Total)	20	19	15	10	9	5
# Parcel Lockers (Total)	0	0	1	2	2	2
# Collection	1	1	1	1	1	1
# BINS	0	0	0	0	0	0
# Mailboxes Under 48"	11	10	6	1	0	0
Module Weight (lbs)	123	122	119	115	113	106

### NOTES:

All standard 4C mailbox modules shown above are fully configurable; visit [florencemailboxes.com/configure](http://florencemailboxes.com/configure) to quickly and easily create your custom solution.

See page 31 for mailbox (MB) and parcel locker (PL) compartment size definitions and configurable options.

Modules noted with an asterisk (\*) do not meet USPS installation specifications and are for private delivery.

All model numbers listed are for front-load modules; add -P for Pedestal-mount modules at the end of the number; see page 34 for additional details.

Actual: 44-1/4"H x 31-9/16"W (Double) or 17-1/2"W (Single) x 17"D / Rough Opening: 43-5/16"H x 30-5/16"W (Double) or 16-1/4"W (Single) x 17"D **12 DOORS HIGH**



4C12D-22* (22 MB1)	4C12S-10* (10 MB1)	4C12S-HOP	4C12S-BIN	4C12D-4P (4 PL6)	4C12S-2P (2 PL6)	Model (Compartment Types)
22	10	0	0	0	0	# Mailboxes
0	0	0	0	4	2	# Parcel Lockers
1	1	1	0	0	0	# Collection
0	0	0	1	0	0	# BINS
18	8	0	0	0	0	# MB under 48"
124	68	66	45	97	53	Module Weight

Actual: 40-3/4"H x 31-9/16"W (Double) or 17-1/2"W (Single) x 17"D / Rough Opening: 39-13/16"H x 30-5/16"W (Double) or 16-1/4"W (Single) x 17"D **11 DOORS HIGH**

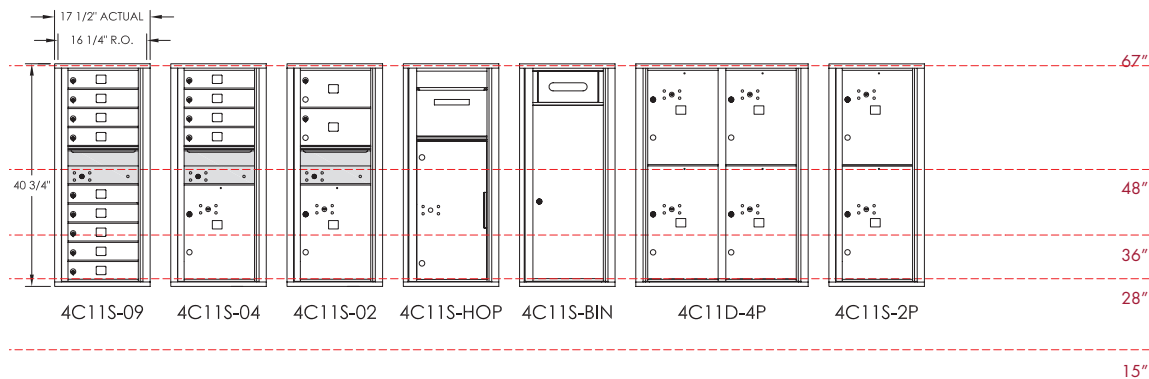

4C11S-09 (9 MB1)	4C11S-04 (4 MB1, 1 PL5)	4C11S-02 (2 MB2, 1 PL5)	4C11S-HOP	4C11S-BIN	4C11D-4P (2 PL5, 2 PL6)	4C11S-2P (1 PL5, 1 PL6)	Model (Compartment Types)
9	4	2	0	0	0	0	# Mailboxes
0	1	1	0	0	4	2	# Parcel Lockers
1	1	1	1	0	0	0	# Collection
0	0	0	0	1	0	0	# BINS
5	0	0	0	0	0	0	# MB under 48"
56	53	50	65	45	99	45	Module Weight

**NOTES:**

All standard 4C mailbox modules shown above are fully configurable; visit [florencemailboxes.com/configure](http://florencemailboxes.com/configure) to quickly and easily create your custom solution.

See page 31 for mailbox (MB) and parcel locker (PL) compartment size definitions and configurable options.

Modules noted with an asterisk (\*) do not meet USPS installation specifications and are for private delivery.

All model numbers listed are for front-load modules; add -P for Pedestal-mount modules at the end of the number; see page 34 for additional details.



## 10 DOORS HIGH

Actual: 37-1/4"H x 31-9/16"W (Double) or 17-1/2"W (Single) x 17"D / Rough Opening: 36-5/16"H x 30-5/16"W (Double) or 16-1/4"W (Single) x 17"D

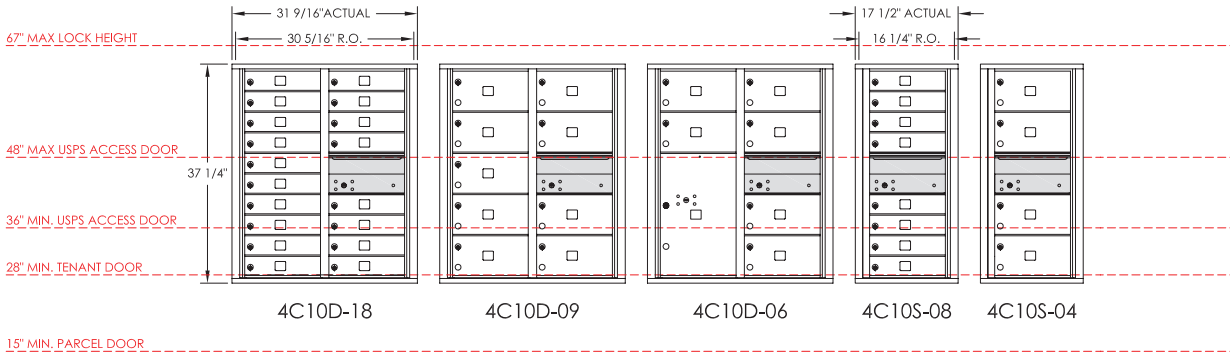

Model (Compartment Types)	4C10D-18 (18 MB1)	4C10D-09 (9 MB2)	4C10D-06 (6 MB2, 1 PL6)	4C10S-08 (8 MB1)	4C10S-04 (4 MB2)
# Mailboxes (Total)	18	9	6	8	4
# Parcel Lockers (Total)	0	0	1	0	0
# Collection	1	1	1	1	1
# BINS	0	0	0	0	0
# Mailboxes Under 48"	10	5	2	4	2
Module Weight (lbs)	97	84	83	56	47

## 10H / ADA MAX

Actual: 37-1/4"H x 31-9/16"W (Double) or 17-1/2"W (Single) x 17"D / Rough Opening: 36-5/16"H x 30-5/16"W (Double) or 16-1/4"W (Single) x 17"D

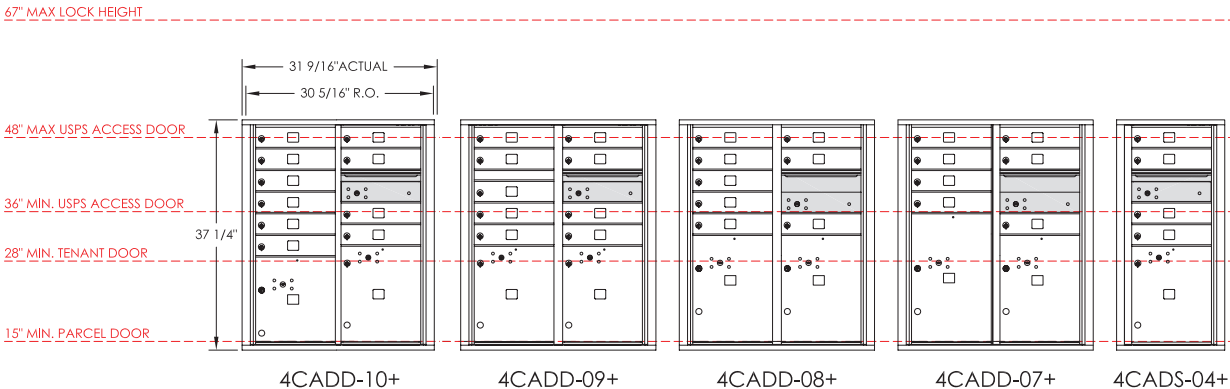

Model (Compartment Types)	4CADD-10+ (10 MB1, 1 PL4, 1 PL15)	4CADD-09+ (9 MB1, 2 PL15)	4CADD-08+ (8 MB1, 2 PL5)	4CADD-07+ (7 MB1, 1 PL5, 1 PL6)	4CADS-04+ (4 MB1, 1 PL15)
# Mailboxes (Total)	10	9	8	7	4
# Parcel Lockers (Total)	2	2	2	2	1
# Collection	1	1	1	1	1
# BINS	0	0	0	0	0
# Mailboxes Under 48"	10	9	8	7	4
Module Weight (lbs)	91	96	88	89	55

### NOTES:

All standard 4C mailbox modules shown above are fully configurable; visit [florencemailboxes.com/configure](http://florencemailboxes.com/configure) to quickly and easily create your custom solution.

See page 31 for mailbox (MB) and parcel locker (PL) compartment size definitions and configurable options.

Modules noted with a plus (+) meet Fair Housing ADA installation requirements.

All model numbers listed are for front-load modules; add -P for Pedestal-mount modules at the end of the number; see page 34 for additional details.

Actual: 37-1/4"H x 31-9/16"W (Double) or 17-1/2"W (Single) x 17"D / Rough Opening: 36-5/16"H x 30-5/16"W (Double) or 16-1/4"W (Single) x 17"D

**10 DOORS HIGH**



4C10S-BIN	4C10S-HOP	4C10D-4P (4 PL5)	Model (Compartment Types)
0	0	0	# Mailboxes
0	0	4	# Parcel Lockers
1	0	0	# Collection
0	1	0	# BINS
0	0	0	# MB under 48"
41	52	80	Module Weight

## Mailbox Configurator

 [florencemailboxes.com/configure](http://florencemailboxes.com/configure)

Florence offers an industry unique online mailbox configurator you can use to create your own versatile™ 4C installation.

This drag and drop tool will help guide you step-by-step, provide you with BIM and/or CAD drawings of your creation, and give you the ability to submit it for a quote.

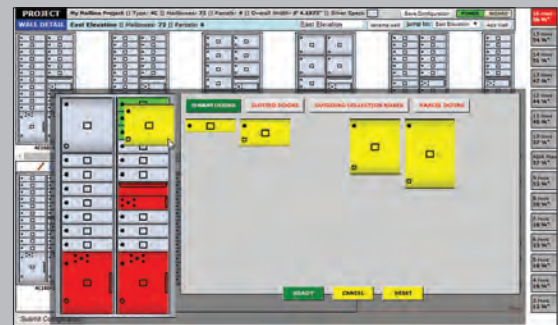

Actual: 37-1/4"H x 31-9/16"W (Double) or 17-1/2"W (Single) x 17"D / Rough Opening: 36-5/16"H x 30-5/16"W (Double) or 16-1/4"W (Single) x 17"D

**10H / ADA MAX**

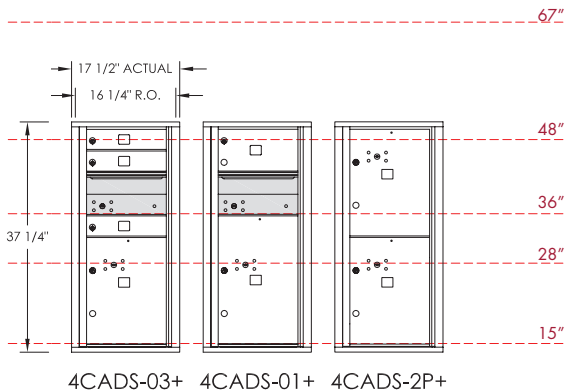

4CADS-03+ (3 MB1, 1 PL5)	4CADS-01+ (1 MB2, 1 PL6)	4CADS-2P+ (2 PL5)	Model (Compartment Types)
3	1	0	# Mailboxes
1	1	2	# Parcel Lockers
1	1	0	# Collection
0	0	0	# BINS
3	1	0	# MB under 48"
49	46	43	Module Weight

## Parcel Locker Requirements

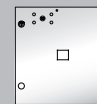

In order to satisfy the USPS STD-4C 1:10 parcel locker to mailbox ratio requirement, parcel lockers (PL) must meet a minimum compartment height of 15 inches.

If the total number of PL in your mailbox installation exceeds the 1:10 requirement, smaller PL may also be included. (See page 31 for more details.)

For example: If your project requires a total of 200 mailboxes, then at least 20 PL with a minimum size of 15"H x 12"W x 15"D must be included. But, if you include more than 20 PL to your 200 mailbox install, then you may also choose to incorporate some smaller PL into the mailbox installation.

⚠ Be sure to note PL height when utilizing only one 4C module type within your installation as not all built-in lockers are 15" tall and may require the addition of parcel only modules in order to comply with the 1:10 PL USPS requirement.

### NOTES:

All standard 4C mailbox modules shown above are fully configurable; visit [florencemailboxes.com/configure](http://florencemailboxes.com/configure) to quickly and easily create your custom solution.

See page 31 for mailbox (MB) and parcel locker (PL) compartment size definitions and configurable options.

Modules noted with a plus (+) meet Fair Housing ADA installation requirements.

All model numbers listed are for front-load modules; add -P for Pedestal-mount modules at the end of the number; see page 34 for additional details.



## 9 HIGH / ADA Actual: 33-3/4"H x 31-9/16"W (Double) or 17-1/2"W (Single) x 17"D / Rough Opening: 32-13/16"H x 30-5/16"W (Double) or 16-1/4"W (Single) x 17"D

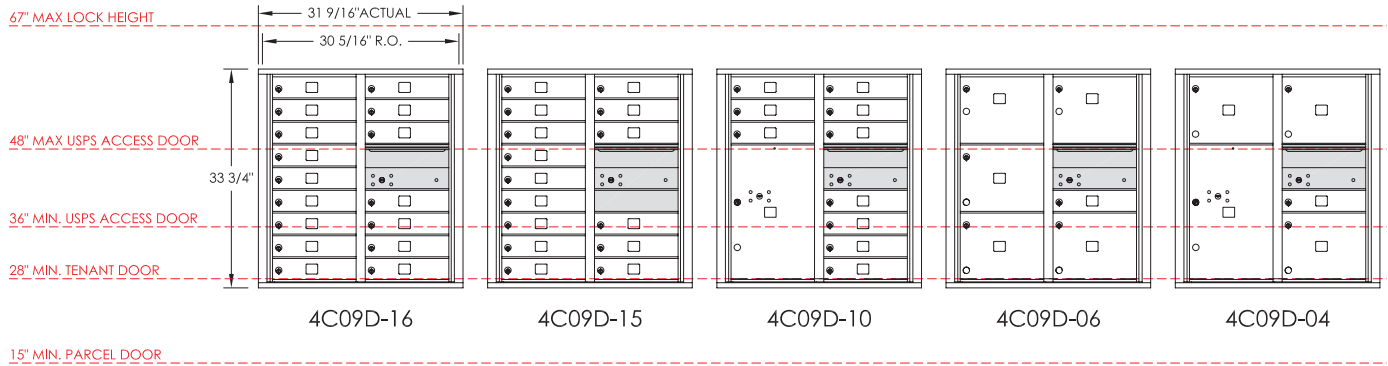

Floor

Model (Compartment Types)	4C09D-16 (16 MB1)	4C09D-15 (15 MB1)	4C09D-10 (10 MB1, 1 PL6)	4C09D-06 (1 MB1, 5 MB3)	4C09D-04 (1 MB1, 3 MB3, 1 PL6)
# Mailboxes (Total)	16	15	10	6	4
# Parcel Lockers (Total)	0	0	1	0	1
# Collection	1	1	1	1	1
# BINS	0	0	0	0	0
# Mailboxes Under 48"	10	9	4	4	2
Module Weight (lbs)	89	88	84	75	76

## 8 HIGH / ADA Actual: 30-1/4"H x 31-9/16"W (Double) or 17-1/2"W (Single) x 17"D / Rough Opening: 29-5/16"H x 30-5/16"W (Double) or 16-1/4"W (Single) x 17"D

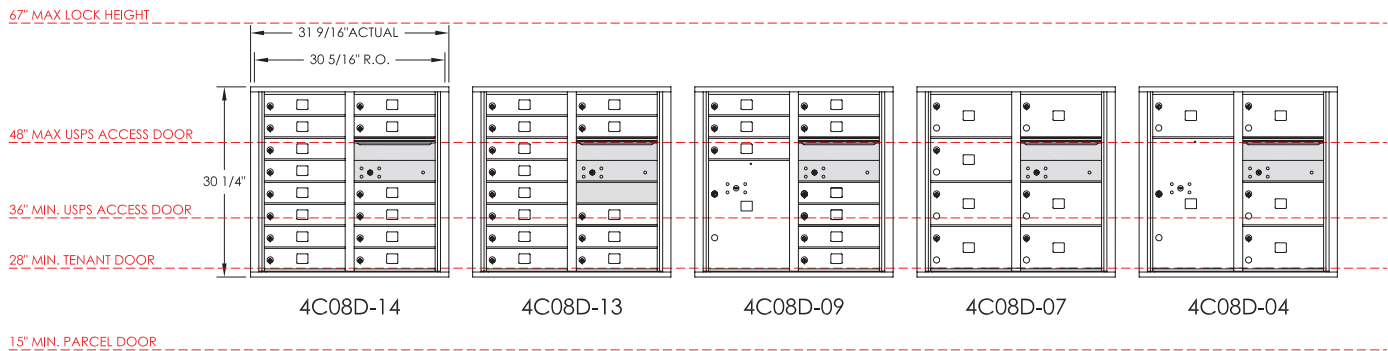

Floor

Model (Compartment Types)	4C08D-14 (14 MB1)	4C08D-13 (13 MB1)	4C08D-09 (9 MB1, 1 PL5)	4C08D-07 (7 MB2)	4C08D-04 (4 MB2, 1 PL6)
# Mailboxes (Total)	14	13	9	7	4
# Parcel Lockers (Total)	0	0	1	0	1
# Collection	1	1	1	1	1
# BINS	0	0	0	0	0
# Mailboxes Under 48"	10	9	5	5	2
Module Weight (lbs)	81	80	78	72	71

### NOTES:

All standard 4C mailbox modules shown above are fully configurable; visit [florencemailboxes.com/configure](http://florencemailboxes.com/configure) to quickly and easily create your custom solution.

See page 31 for mailbox (MB) and parcel locker (PL) compartment size definitions and configurable options.

All model numbers listed are for front-load modules; add -P for Pedestal-mount modules at the end of the number; see page 34 for additional details.

Actual: 33-3/4"H x 31-9/16"W (Double) or 17-1/2"W (Single) x 17"D / Rough Opening: 32-13/16"H x 30-5/16"W (Double) or 16-1/4"W (Single) x 17"D **9 HIGH / ADA**



4C09S-07 (7 MB1)	4C09S-02 (2 MB1, 1 PL5)	4C09S-HOP	4C09S-BIN	4C09D-4P (2 PL4, 2 PL5)	4C09S-2P (1 PL4, 1 PL5)	Model (Compartment Types)
7	2	0	0	0	0	# Mailboxes
0	1	0	0	4	2	# Parcel Lockers
1	1	1	0	0	0	# Collection
0	0	0	1	0	0	# BINS
4	0	0	0	0	0	# MB under 48"
48	45	52	41	76	40	Module Weight

Actual: 30-1/4"H x 31-9/16"W (Double) or 17-1/2"W (Single) x 17"D / Rough Opening: 29-5/16"H x 30-5/16"W (Double) or 16-1/4"W (Single) x 17"D **8 HIGH / ADA**

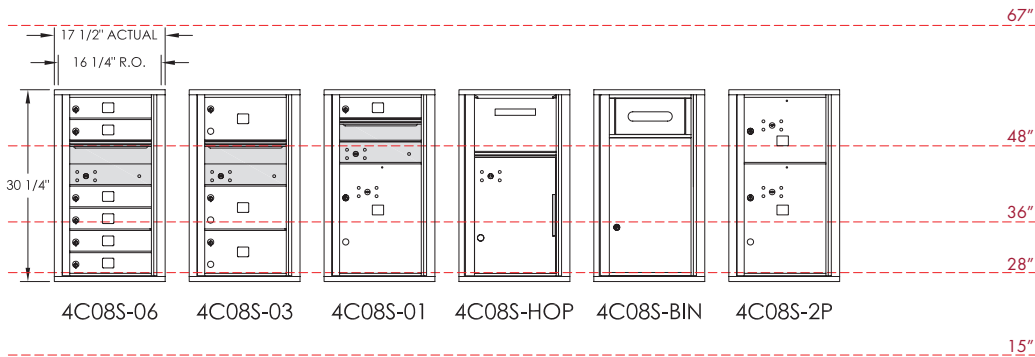

4C08S-06 (6 MB1)	4C08S-03 (3 MB2)	4C08S-01 (1 MB1, 1 PL5)	4C08S-HOP	4C08S-BIN	4C08S-2P (1 PL3, 1 PL5)	Model (Compartment Types)
6	3	1	0	0	0	# Mailboxes
0	0	1	0	0	2	# Parcel Lockers
1	1	1	1	0	0	# Collection
0	0	0	0	1	0	# BINS
4	2	0	0	0	0	# MB under 48"
44	40	40	52	44	37	Module Weight

**NOTES:**

All standard 4C mailbox modules shown above are fully configurable; visit [florencemailboxes.com/configure](http://florencemailboxes.com/configure) to quickly and easily create your custom solution.

See page 31 for mailbox (MB) and parcel locker (PL) compartment size definitions and configurable options.

All model numbers listed are for front-load modules; add -P for Pedestal-mount modules at the end of the number; see page 34 for additional details.

## 7 HIGH / ADA Actual: 26-3/4"H x 31-9/16"W (Double) or 17-1/2"W (Single) x 17"D / Rough Opening: 25-13/16"H x 30-5/16"W (Double) or 16-1/4"W (Single) x 17"D

67" MAX LOCK HEIGHT

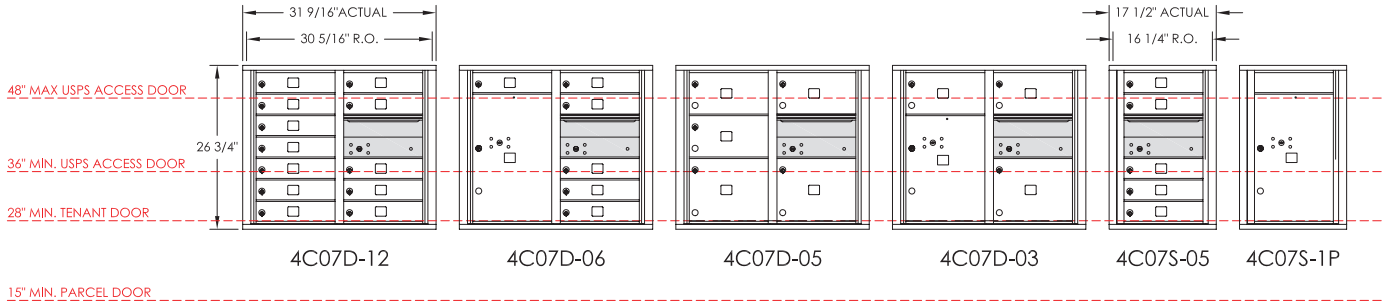

15" MIN. PARCEL DOOR

Floor

Model (Compartment Types)	4C07D-12 (12 MB1)	4C07D-06 (6 MB1, 1 PL6)	4C07D-05 (3 MB2, 2 MB3)	4C07D-03 (2 MB2, 1 MB3, 1 PL5)	4C07S-05 (5 MB1)	4C07S-1P (1 PL6)
# Mailboxes (Total)	12	6	5	3	5	0
# Parcel Lockers (Total)	0	1	0	1	0	1
# Collection	1	1	1	1	1	0
# BINS	0	0	0	0	0	0
# Mailboxes Under 48"	10	4	3	1	4	0
Module Weight (lbs)	73	68	64	65	40	32

## 6 HIGH / ADA Actual: 23-1/4"H x 31-9/16"W (Double) or 17-1/2"W (Single) x 17"D / Rough Opening: 22-5/16"H x 30-5/16"W (Double) or 16-1/4"W (Single) x 17"D

67" MAX LOCK HEIGHT

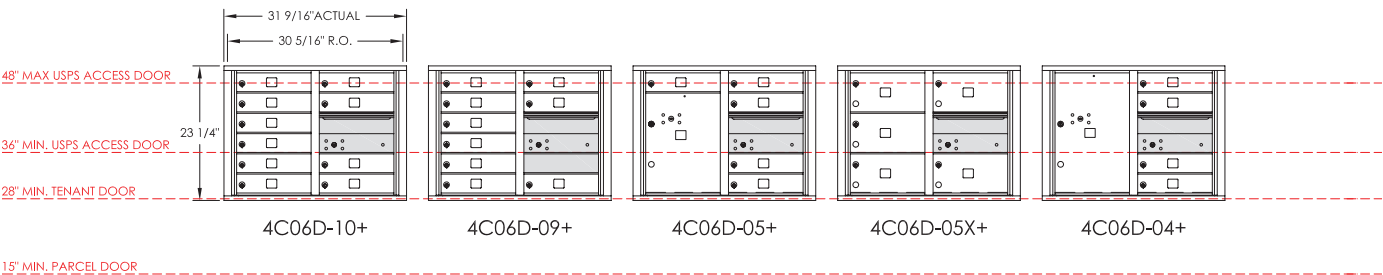

15" MIN. PARCEL DOOR

Floor

Model (Compartment Types)	4C06D-10+ (10 MB1)	4C06D-09+ (9 MB1)	4C06D-05+ (5 MB1, 1 PL5)	4C06D-05X+ (5 MB2)	4C06D-04+ (4 MB1, 1 PL6)
# Mailboxes (Total)	10	9	5	5	4
# Parcel Lockers (Total)	0	0	1	0	1
# Collection	1	1	1	1	1
# BINS	0	0	0	0	0
# Mailboxes Under 48"	10	9	5	5	4
Module Weight (lbs)	66	65	59	62	61

### NOTES:

All standard 4C mailbox modules shown above are fully configurable; visit [florencemailboxes.com/configure](http://florencemailboxes.com/configure) to quickly and easily create your custom solution.

See page 31 for mailbox (MB) and parcel locker (PL) compartment size definitions and configurable options.

Modules noted with a plus (+) meet Fair Housing ADA installation requirements.

All model numbers listed are for front-load modules; add -P for Pedestal-mount modules at the end of the number; see page 34 for additional details.



**5 HIGH / ADA** Actual: 19-3/4"H x 31-9/16"W (Double) or 17-1/2"W (Single) x 17"D / Rough Opening: 18-13/16"H x 30-5/16"W (Double) or 16-1/4"W (Single) x 17"D

67" MAX LOCK HEIGHT

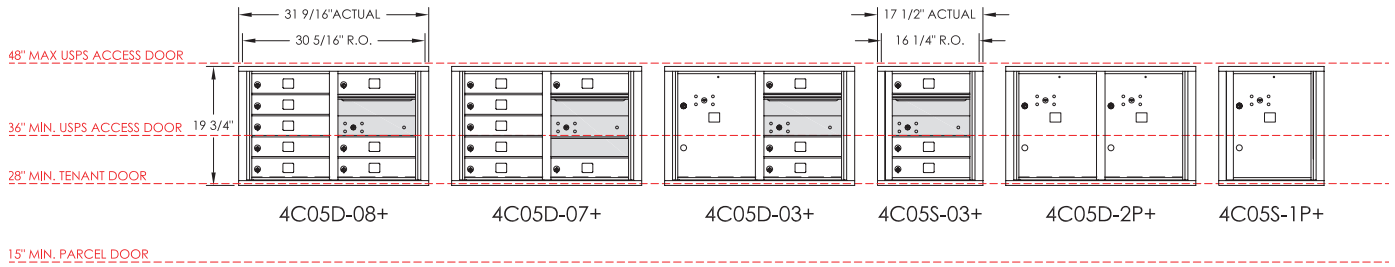

15" MIN. PARCEL DOOR

Floor

Model (Compartment Types)	4C05D-08+ (8 MB1)	4C05D-07+ (7 MB1)	4C05D-03+ (3 MB1, 1 PL5)	4C05S-03+ (3 MB1)	4C05D-2P+ (2 PL5)	4C05S-1P+ (1 PL5)
# Mailboxes (Total)	8	7	3	3	0	0
# Parcel Lockers (Total)	0	0	1	0	2	1
# Collection	1	1	1	1	0	0
# BINS	0	0	0	0	0	0
# Mailboxes Under 48"	8	7	3	3	0	0
Module Weight (lbs)	58	57	55	31	49	26

Actual: 23-1/4"H x 31-9/16"W (Double) or 17-1/2"W (Single) x 17"D / Rough Opening: 22-5/16"H x 30-5/16"W (Double) or 16-1/4"W (Single) x 17"D **6 HIGH / ADA**

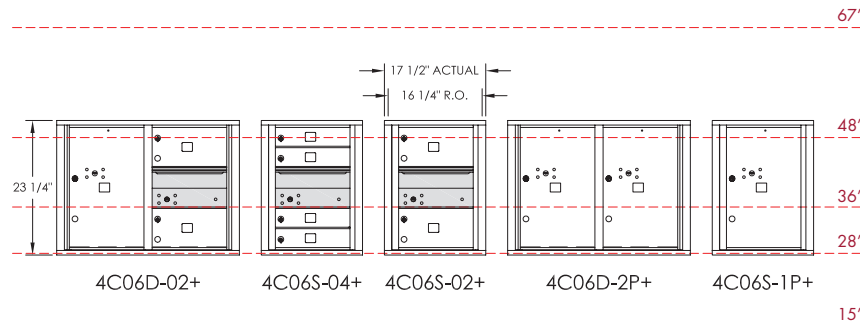

4C06D-02+ (2 MB2, 1 PL6)	4C06S-04+ (4 MB1)	4C06S-02+ (2 MB2)	4C06D-2P+ (2 PL6)	4C06S-1P+ (1 PL6)	Model (Compartment Types)
2	4	2	0	0	# Mailboxes
1	0	0	2	1	# Parcel Lockers
1	1	1	0	0	# Collection
0	0	0	0	0	# BINS
2	4	2	0	0	# MB under 48"
58	36	33	53	28	Module Weight

**New Video:  
What Makes Us**

To learn more about Florence and 'What Makes Us', be sure to check out our company video on the Florence Corporation YouTube Channel or on our website: [florencemailboxes.com/videos](http://florencemailboxes.com/videos).

Also found in the same location is our video library, which is expanding regularly to show you how the mailboxes function, how to perform ongoing maintenance, and introductions of your dedicated Florence team!



**NOTES:**

All standard 4C mailbox modules shown above are fully configurable; visit [florencemailboxes.com/configure](http://florencemailboxes.com/configure) to quickly and easily create your custom solution.

See page 31 for mailbox (MB) and parcel locker (PL) compartment size definitions and configurable options.

Modules noted with a plus (+) meet Fair Housing ADA installation requirements.

All model numbers listed are for front-load modules; add -P for Pedestal-mount modules at the end of the number; see page 34 for additional details.

# INSTALLATION AND ACCESSIBILITY REFERENCES

Designing appropriate accessibility into every feature of a facility is a key consideration for any project, and how the mailboxes are installed into that facility is no exception. Plus, all wall-mounted mailboxes which will be serviced by the U.S. Postal Service (USPS) must also be installed according to specifications as outlined in the USPS STD-4C regulation.

To assist you with selecting mailboxes that meet the specific requirements of your project, details related to installed heights are noted on the Florence versatile™ 4C mailbox modules references on pages 18 - 29. Below are also the quick references related to accessible uses and USPS requirements to help you in determining your project layout and design.

## Meeting USPS Installation Requirements

Florence Corporation USPS Approved 4C mailbox products are designed to adhere to STD-4C regulations. To ensure your project complies with USPS regulations for wall-mounted mailboxes, your mailbox center must be installed according to the following U.S. Postal Service guidelines:

### Installation requirements specified in the U.S. Postal Service STD-4C regulation are outlined below:

1. At least one customer compartment shall be positioned less than 48 inches above the finished floor.
2. No parcel locker compartment (interior bottom shelf) shall be positioned less than 15 inches above the finished floor.
3. No customer lock shall be located more than 67 inches above the finished floor.
4. No customer compartment (interior bottom shelf) shall be positioned less than 28 inches above the finished floor.
5. The USPS Arrow lock shall be located between 36 and 48 inches above the finished floor.

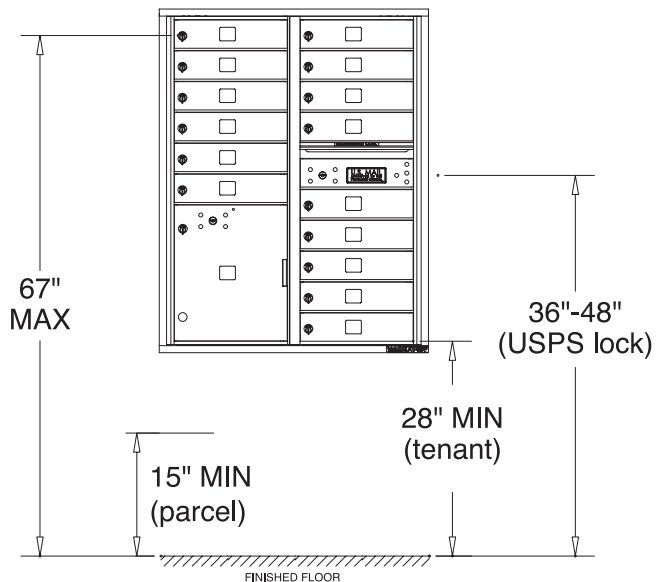

*Standards Governing the Design of Wall-Mounted Centralized Mail Receptacles. Federal Register/Vol. 69, No 171/September 3, 2004 Rules and Regulations POSTAL SERVICE, 39 CFR Part 111. [www.gpo.gov/fdsys/pkg/FR-2004-09-03/pdf/04-19781.pdf](http://www.gpo.gov/fdsys/pkg/FR-2004-09-03/pdf/04-19781.pdf)*

## Meeting ADA Installation Requirements

Accessibility regulations may vary by type of facility and by governing jurisdictions. Therefore, always consult local building officials and codes for applicable accessibility requirements that could affect your mailbox project. Below are industry references for your convenience.

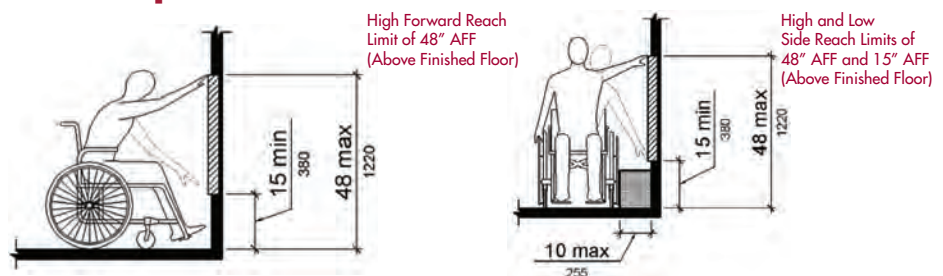

*2010 ADA Standards for Accessible Design, Department of Justice Code of Federal Regulations, ADA CHAPTER 2: SCOPING REQUIREMENTS, 228.2 Mail Boxes: Where mail boxes are provided in an interior location, at least 5 percent, but no fewer than one, of each type shall comply with 309. In residential facilities, where mail boxes are provided for each residential dwelling unit, mail boxes complying with 309 shall be provided for each residential dwelling unit required to provide mobility features complying with 809.2 through 809.4.*

The full text can be found at: [www.ada.gov/2010ADASTandards\\_index.htm](http://www.ada.gov/2010ADASTandards_index.htm)

# CUSTOMIZE 4C MODULES TO FIT YOUR NEEDS

Not every installation has a standard solution and Florence is proud to support your custom needs. . .especially when it comes to private delivery solutions. So, whether you want a certain look that takes your installation to new heights by adding faux mailboxes (like this installation in New York, NY) or you need something outside the nearly 120 standard pre-configured mailbox modules, we can help.

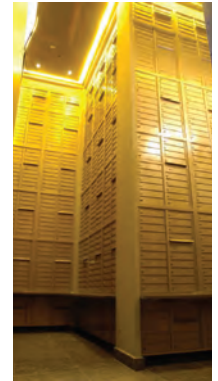

Let your imagination soar with our industry unique online mailbox configurator. Here, you can easily drag and drop mailboxes or swap compartment types, all at the click of your mouse. Visit [florencemailboxes.com/configure](http://florencemailboxes.com/configure) to get started.

## 4C Module Custom Compartment Options (All compartments are 12" W x 15" D)

Sometimes, a standard sized compartment is simply not big enough to suit your residents' needs; especially with the growing capacity needs for package delivery! That is why Florence's versatile™ 4C product line offers several different compartment types and sizes, all designed to accommodate increased capacity for your residents. Heights shown below are designed to replace corresponding number of regular sized tenant compartments (One-High); for example, a Two-High compartment replaces two One-High compartments.

	Tenant Compartments	Outgoing Mail Collection Compartments	Tenant Compartments with Drop Slot	Parcel Locker Compartments
<b>One-High</b> (3" H)	 MB1	 OM1	 DS1 *	
<b>Two-High</b> (6-1/2" H)	 MB2	 OM2	 DS2 *	 PL2 †
<b>Three-High</b> (10" H)	 MB3	 OM3	 DS3 *	 PL3 †
<b>Four-High</b> (13-1/2" H)	 MB4	 OM4	 DS4 *	 PL4 †
<b>Five-High</b> (17" H)	 MB5	 OM5	 DS5 *	 PL5
				 PL6

\* For Private Delivery, Not USPS Approved  
Slot Dims: 1/2"H or 1"H x 9-5/8" W

† For Private Delivery, unless parcel locker ratio exceeds requirement - see below for full details

† To satisfy the USPS STD-4C 1:10 parcel locker to mailbox ratio requirement, parcel lockers (PL) must meet a minimum compartment height of 15". If the total number of PL in the mailbox installation exceeds the 1:10 requirement, smaller PL may also be included. For example: If a project requires 200 mailboxes, then at least 20 PL with a minimum size of 15"H x 12"W x 15"D must be included. But, if you add more than 20 PL to the 200 mailboxes, then you may also choose to incorporate some smaller PL into the installation. Be sure to note PL height when utilizing only one 4C module type in your entire installation as not all built-in lockers are 15" and may require addition of parcel only modules to meet the 1:10 requirements (e.g. 4C13D-16).



# Installation Alternatives

## Options for STD-4C Mounting

### Recessed Mounting



All standard 4C modules are designed to be recessed into their mounting; whether it is directly into a wall, enclosure, or casing. The most common way to install the 4C modules is into a wall. Florence makes installation easy by providing a **Multi-Unit Connector Kit (MUCK)** for each specified module. This connector can be used to secure multiple units across a larger rough opening, eliminating the

need for studs. It also ensures your installation has a clean look as units are pulled together tightly so they are mounted flush to one another, reducing any potential gaps between modules.

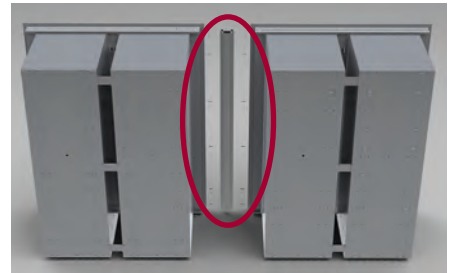

### Surface Mounting



By utilizing the surface-mount collar, 4C modules can be installed flush onto a wall. This installation alternative is ideal for settings with limited wall depth or material that is difficult to cut in a rough opening - like brick or marble. The 4C module is simply mounted into an assembled collar to provide a finished, sleek look to your installation. (See page 33 for details.)

### Pedestal Mounting

Mounting a USPS Approved 4C module on a pedestal is not a postal approved installation alternative, but is an excellent solution for any private delivery application. Pedestals are designed to ensure the selected module is installed at a standard accessible height, making installation quick and easy. (See details on pages 34 - 35.)



## Mailbox Enclosures Provide Greater Flexibility



### Surface-Mount Collars

Designed for indoor or outdoor use, Florence is pleased to offer a heavy-duty STD-4C mailbox enclosure which allows modules to quickly and easily be mounted to any flat surface. This smooth aluminum collar ensures the mail system achieves that desired sleek, finished look while easily attaching directly to the mailbox module. Ideal for settings with limited wall depth, this USPS Approved solution provides greater flexibility in your mailbox placement and installation.

### Product Features

- 4C collars are designed to fit and attach easily to ALL front-loading versatile™ 4C modules for both single- and double-wide configurations.
- All aluminum construction in rugged, weather-resistant powder coat finishes (see color options below).
- Easy-to-assemble collar has industry EXCLUSIVE slotted back designed for ease in installation and reduction of overall unit weight.

**FLORENCE**  
EXCLUSIVE PRODUCT



SM##D



SM##S

(Note: ## = selected suite height, e.g. SM14D)



[florencemailboxes.com/4C](http://florencemailboxes.com/4C)

### Color Options

Customize your surface mount collar with one of eight different architectural color options, all in a durable, powder coat finish.

Colors shown are representative of the actual powder coat finish but are limited by printing conditions and may vary slightly from finished product.



Antique Bronze (AB)



Black (BK)



Dark Bronze (DB)



Gold Speck (GS)



Postal Grey (PG)



Sandstone (SD)



Silver Speck (SS)



White (WH)

# Pedestal-Mounted Mailboxes

## *Added Flexibility for Private Delivery*



With all the same features and options, security, and durability of the Florence wall-mounted versatile™ 4C modules, pedestal mounting simply adds greater flexibility to your project as it is not tied to the USPS regulations. Designed to ensure every module is at a standard accessible height, pedestal-mount units come prepared with a master commercial lock to provide easy access to all compartments at once.

Ideal for centralized mail delivery applications where the USPS letter carrier delivers to a single location and the facility manager or entrusted individual then distributes the mail to the resident compartments.

## Product Applications

- Military Housing (*right*)
- Off-campus Student Housing
- On-campus Residence Halls
- Gated/Guarded Facility
- Book Collection
- Rent Payment Collection
- Multi-Media Drop Off
- Key Returns/Collection
- College Campus
- Private Medical Facility (*above*)
- Financial Institutions
- K-12 Schools



## Color Options

*Customize your 4CPM with one of eight different architectural color options, all in a durable, powder coat finish.*

Colors shown are representative of the actual powder coat finish but are limited by printing conditions and may vary slightly from finished product.



Antique Bronze  
(AB)



Black  
(BK)



Dark Bronze  
(DB)



Gold Speck  
(GS)



Postal Grey  
(PG)



Sandstone  
(SD)



Silver Speck  
(SS)



White  
(WH)



## Product Features









- All versatile™ 4C modules are factory-installed in an aluminum outer casing.
- Matching aluminum pedestal snaps to unit for convenient outdoor installation.
- Integrated collection slot with weather protection hood and anti-fishing comb.
- Master front-loading door has interlocking, overlapping seams to prevent prying.
- Ability to swap standard collection compartment with a larger two-, three-, four- or five-high collection compartment.
- Hardy stainless steel latching hook cam on every compartment door with EXCLUSIVE double-latching cam on all oversized doors.
- EXCLUSIVE double-latching parcel locking mechanism design for added door security and strength.

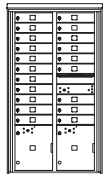
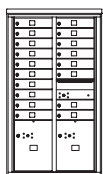
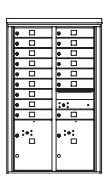
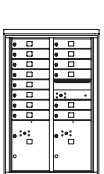
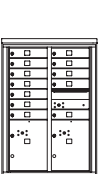

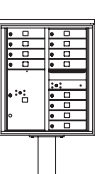
Free-standing collection boxes may be approved for USPS collection if local postal officials authorize use and location.

 [florencemailboxes.com/4CPM](http://florencemailboxes.com/4CPM)

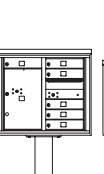
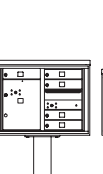
**NOTE:** To view all standard pre-configured pedestal-mounted module options, see pages 18 - 29. For Pedestal-Mount Module numbers, simply add “-P” to the end of the front-load module numbers shown. Listed weights in Quick Reference Guide are for modules only and do not include weight of pedestal or outer cabinet. Pedestal-mount module dimensions are listed below:

												
Max Height	15 High Suite	14 High Suite	13 High Suite	12 High Suite	11 High Suite	10 High Suite	ADA Suite	9 High Suite	8 High Suite	7 High Suite	6 High Suite	5 High Suite
72-3/16”H	70-7/16”H	66-15/16”H	63-7/16”H	59-15/16”H	69-7/16”H	65-15/16”H	52-15/16”H	62-7/16”H	58-15/16”H	55-7/16”H	52”H	48-7/16”H

Overall pedestal-mount module dimensions: (Shown above) H x 32-13/16” W (Double) or 18-3/4” W (Single) x 17-3/4” D

## cluster box units

 [florencemailboxes.com/CBU](http://florencemailboxes.com/CBU)

If your project calls for USPS Approved pedestal-mount units, be sure to check out the Florence vital™ cluster box unit product line. Complete with industry EXCLUSIVE units, decorative accessories, and additional parcel only units (pages 10-11), this line of outdoor delivery equipment will be sure to fill your needs.



1570-8

1570-12

1570-16

1570-13

1570-4T5

1570-8T6





# Replacement Mailboxes

## *Horizontal and Vertical Units*



Florence has been designing and manufacturing mailboxes for centralized delivery since 1934 and is proud to continue building its horizontal and vertical mailboxes for your postal replacement and private delivery applications.

Postal Delivery is when the USPS Letter Carrier delivers mail to each existing tenant compartment in a mailbox installation, while private delivery is when the letter carrier simply drops all the mail at one location and another entrusted individual places it into all the individual tenant compartments - most commonly used in university and military housing settings.

Mailboxes for private delivery do not have to conform to current postal regulations and therefore often vary in size and installation requirements from standard USPS Approved equipment.

Due to changes in postal regulations, these older style horizontal and vertical mailboxes may now only be used to replace a current installation of similar mailboxes when no modification of the existing wall opening will be made. However, if the rough opening dimensions will be changed during a replacement or remodel, or the install is for new construction, STD-4C equipment will be required (*see pages 12 - 29 for product details*).





Vertical mailboxes come in five standard sizes and easily slip into the opening vacated by an older box; however, it is highly recommended that existing vertical mailboxes be upgraded to either a CBU or STD-4C to ensure proper security. As mail is loaded from the top of these vertical units, it makes them vulnerable to the weather so should only be used indoors only.

Horizontal mailboxes are an economical solution for your private centralized mail delivery needs when a large number of mailboxes are needed within a limited amount of indoor wall space. As these mailboxes were designed to meet

specifications which are 30+ years old, they should be protected from the weather and only installed indoors as they do not include the same weather resistant features or security features as the STD-4C mail equipment of today.

To quickly and easily design your horizontal mailbox installation, Florence has developed an easy-to-use mailbox configurator which is unique to the industry. This do-it-yourself online tool offers both a wizard mode featuring all standard modules for novices and an advanced power mode for those that want to upgrade their installation with optional features and door sizes.



Mount these horizontal mailboxes in large banks, or on multiple walls.



Vertical mailboxes have top-loading tall and skinny compartments.



# 1400 Series - Standard

## for Postal Delivery



 [florencemailboxes.com/horizontal](http://florencemailboxes.com/horizontal)

As an indoor solution, these traditional-style mailboxes are most popular in apartment complexes, and university/military housing. The standard for decades, these are available as replacement units for worn out installations. (All new construction must use the new postal STD-4C mailboxes, see page 30 for details.)

### Standard Features

- Front load
- Recess-mounted
- Prepared for USPS installed Master Lock
- Anodized aluminum finish
- 5-pin cylinder tenant cam lock with two keys (1,000 key changes) see page 40
- Snap-on outer trim kit (available by request)
- Clear plastic number slots or engraved numbers

### Door Sizes

Standard horizontal mailboxes are pre-configured with the following door sizes:

#### Tenant Compartments

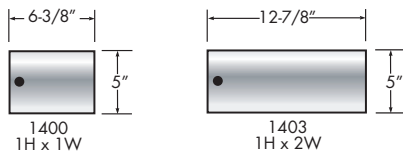

#### Plastic Number Slot:

Number slots are 5/8" H x 2" W.

**Engraving:** Custom engraving utilizes the USPS Standard *US Block* font and is 3/4" tall. All engraving can include up to 5 characters in one line per door.

#### Collection Compartment

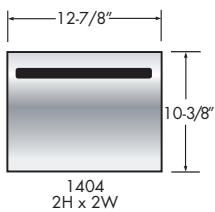

#### Parcel Locker Compartments

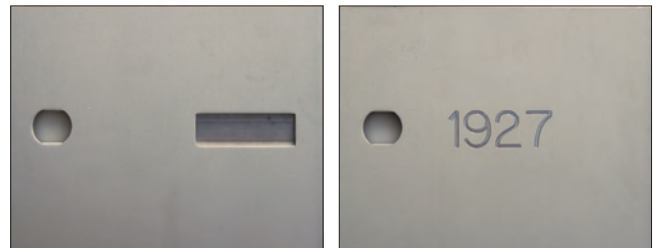
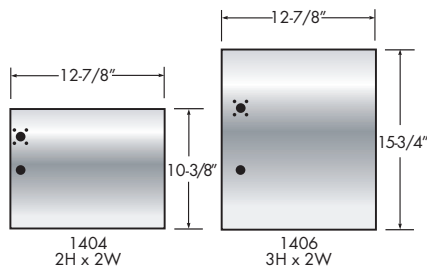

If your installation needs a little more customization than available on the standard 1400 series, select the custom 1400 series to swap doors and lock types. See pages 40 - 41 for details.

Note: Horizontal mailbox installations should be protected from direct exposure to the weather; Florence is not responsible for damage caused by weather conditions as these products are rated for indoor use only.

# Horizontal Mailboxes

## 5 DOORS HIGH Actual: 28" H / Rough Opening: 28-1/4" H

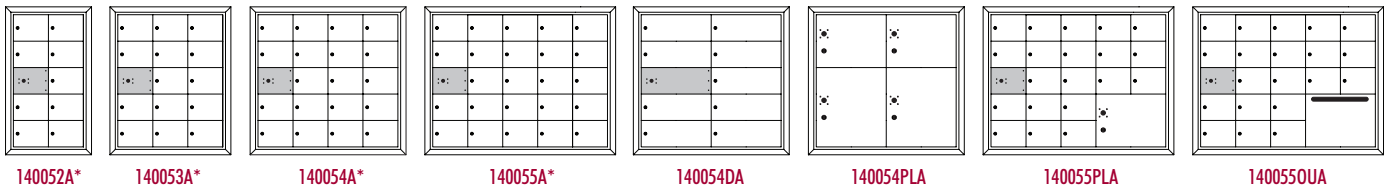

Model	140052A*	140053A*	140054A*	140055A*	140054DA	140054PLA	140055PLA	1400550UA
# Mailboxes (Total)	9	14	19	24	9	0	20	20
# Parcel Lockers (Total)	0	0	0	0	0	4	1	0
# Collection	0	0	0	0	0	0	0	1
Actual Width	14-3/8"	20-3/4"	27-1/4"	33-5/8"	27-1/4"	27-1/4"	33-5/8"	33-5/8"
Rough Opening Width	14-5/8"	21"	27-1/2"	33-7/8"	27-1/2"	27-1/2"	33-7/8"	33-7/8"

## 6 DOORS HIGH Actual: 33-3/8" H / Rough Opening: 33-5/8" H

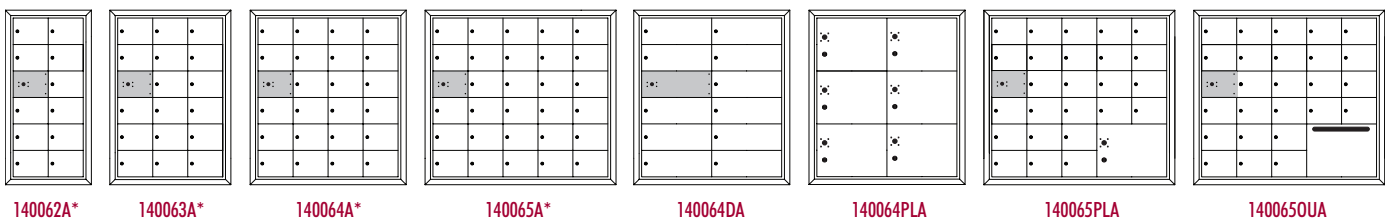

Model	140062A*	140063A*	140064A*	140065A*	140064DA	140064PLA	140065PLA	1400650UA
# Mailboxes (Total)	11	17	23	29	11	0	25	25
# Parcel Lockers (Total)	0	0	0	0	0	6	1	0
# Collection	0	0	0	0	0	0	0	1
Actual Width	14-3/8"	20-3/4"	27-1/4"	33-5/8"	27-1/4"	27-1/4"	33-5/8"	33-5/8"
Rough Opening Width	14-5/8"	21"	27-1/2"	33-7/8"	27-1/2"	27-1/2"	33-7/8"	33-7/8"

## 7 DOORS HIGH Actual: 38-3/4" H / Rough Opening: 39" H

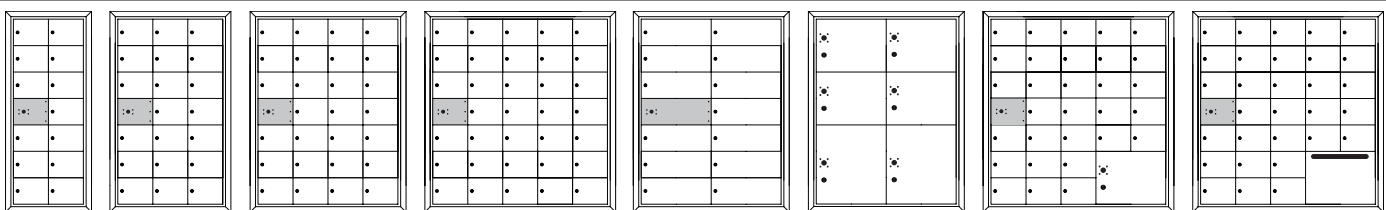

Model	140072A*	140073A*	140074A*	140075A*	140074DA	140074PLA	140075PLA	1400750UA
# Mailboxes (Total)	13	20	27	34	13	0	30	30
# Parcel Lockers (Total)	0	0	0	0	0	6	1	0
# Collection	0	0	0	0	0	0	0	1
Actual Width	14-3/8"	20-3/4"	27-1/4"	33-5/8"	27-1/4"	27-1/4"	33-5/8"	33-5/8"
Rough Opening Width	14-5/8"	21"	27-1/2"	33-7/8"	27-1/2"	27-1/2"	33-7/8"	33-7/8"

### NOTES:

Standard modules noted with an asterisk (\*) are fully configurable; visit [florencemailboxes.com/configure](http://florencemailboxes.com/configure) to quickly and easily create your custom solution.

See pages 40-41 for compartment size definitions and configurable options.

All model numbers listed are for standard front-load modules; add -SP for custom modules at the end of the number.

# 1400 Series - Custom

## for Postal or Private Delivery



Providing an opportunity for greater flexibility in door size and type selection, the Florence 1400 Custom Series allows you to upgrade your horizontal mailboxes to fit your installation needs. This configurable solution lets you be the designer as you place the doors where you want them instead of being tied to a pre-determined standard module (see door size chart on opposite page for options).

 [florencemailboxes.com/configurator](http://florencemailboxes.com/configurator)



**Note:** Horizontal mailbox installations should be protected from direct exposure to the weather; Florence is not responsible for damage caused by weather conditions as these products are rated for indoor use only.

### Optional Features

- Private master lock
- Eight powder coat color finishes
- Combination lock (for private services only)
- Configurable door sizes and layout options

### Lock Selections

Cam-lock is USPS Approved and standard on all horizontal mailboxes. Lock comes with two keys (1,000 key changes). Combination lock option for Private Delivery only.

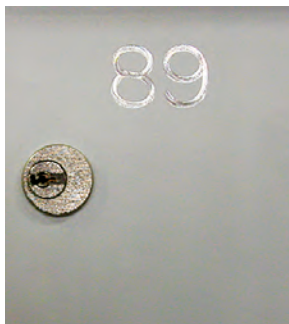

*For lock maintenance, only graphite type lubricants are recommended on product locks. For additional assistance with locks, contact your local locksmith.*



### Color Options

Anodized Aluminum is standard for all horizontal mailboxes. Upgrade your installation to one of eight different architectural color options, all in a durable, powder coat finish.

*Colors shown are representative of the actual powder coat finish but are limited by printing conditions and may vary slightly from finished product.*

<b>Antique Bronze (AB)</b> PMS 8622C	<b>Black (BK)</b> PMS Black 6C	<b>Dark Bronze (DB)</b> PMS Black 7C	<b>Gold Speck (GS)</b> PMS 7-5C
<b>Postal Grey (PG)</b> PMS 413C	<b>Sandstone (SD)</b> PMS 7501C	<b>Silver Speck (SS)</b> PMS 877C	<b>White (WH)</b> PMS White



## Configurable Modules



Sometimes a standard sized compartment is simply not big enough to suit your residents' needs. That's why you can change mail compartment sizes or add as many collection and/or parcel lockers as your installation requires. Simply begin with an all tenant standard module found on page 39, and modify it by placing any of the various door sizes and types found in the chart below.

To quickly design your custom horizontal mailbox installation, Florence has developed an easy-to-use mailbox configurator which is unique to the industry. This do-it-yourself online tool provides the opportunity for you to place the doors not only where you want them, but with as many as you want. So go ahead, add two collection boxes - one for rent, one for mail in your design; it's your mailbox!

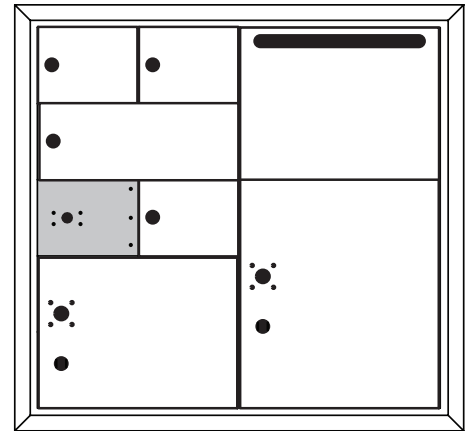

Our configurator tool does the math for you, provides a drawing and even allows you to submit your creation for quote!

## Door Sizes

Configurable units available in cabinet sizes 2 - 5 Wide and 5 - 7 High.

	Tenant Compartments	Collection Compartments	Parcel Locker Compartments
<b>1400</b> <b>One-High, One-Wide</b> (5" H x 6-3/8" W)		 NOTE: Collection compartments are available with or without an access lock.	
<b>1403</b> <b>One-High, Two-Wide</b> (5" H x 12-7/8" W)			
<b>1404</b> <b>Two-High, Two-Wide</b> (10-3/8" H x 12-7/8" W)			
<b>1406</b> <b>Three-High, Two-Wide</b> (15-3/4" H x 12-7/8" W)			

# 1600/1700 Series - Standard

*for Private Delivery*



A favorite of University housing managers, this indoor solution helps keep your mail area organized. Available in front-loading (1600 series) or rear-loading (1700 series) units, each module provides a lot of compartments in a small space. Since these are private delivery mailboxes, they are not constrained by postal installation regulations and therefore have no minimum or maximum mounting height requirements.

## Standard Features

- Front load, Recess-mounted
- Anodized aluminum finish
- 5-pin cylinder tenant cam lock with two keys (1,000 key changes) see page 46
- Snap-on outer trim kit (available by request)
- Clear plastic number slots or engraved numbers

**Rear-load mailboxes (1700 series)** have an exposed back for easy distribution, so keep in mind during planning that additional space will be necessary for a secure room behind the installation. Access to this room may be easily restricted using a key keeper (see page 50) with a private lock.

### Plastic Number Slot:

Number slots are 5/8" H x 2" W.

**Engraving:** Custom engraving utilizes the USPS Standard *US Block* font and is 3/4" tall. All engraving can include up to 5 characters on one line per door.



**Door Size:** All standard units contain one door size. If you need more than the standard configurations shown on pages 43-45, our easy-to-use online configurator allows you to complete your project from the full range of size options - see page 47 for details.

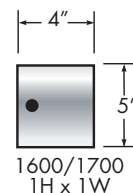

# Horizontal Mailboxes

## 7 DOORS HIGH Actual: 38-3/4"H / Rough Opening: 39"H

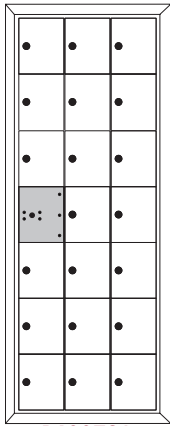

160073A

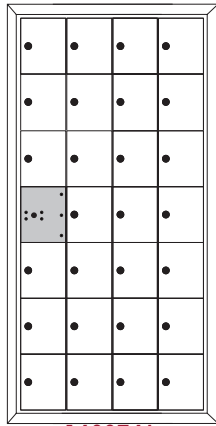

160074A

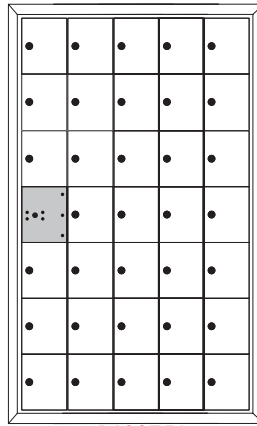

160075A

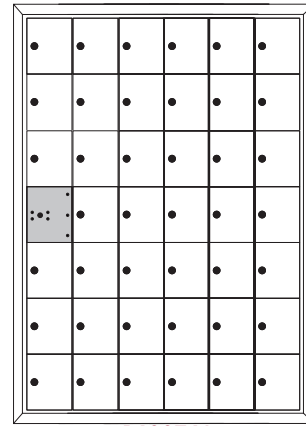

160076A

Model	160073A	160074A	160075A	160076A
# Mailboxes (Max)	20	27	34	41
Actual Width	13-3/4"	17-13/16"	21-7/8"	25-15/16"
Rough Opening Width	14"	18-1/16"	22-1/8"	26-3/16"

## 8 DOORS HIGH Actual: 44-3/16"H / Rough Opening: 44-7/16"H

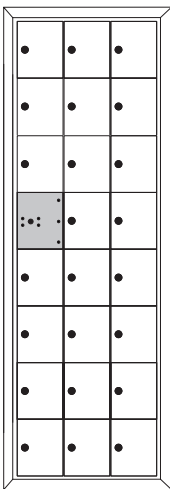

160083A

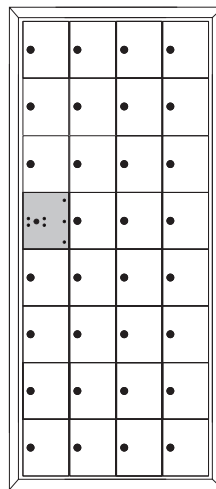

160084A

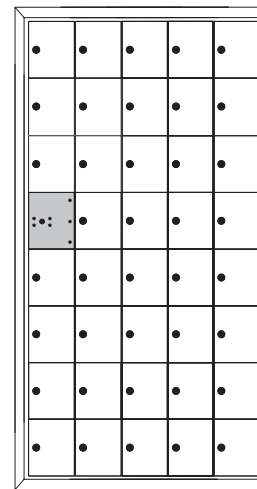

160085A

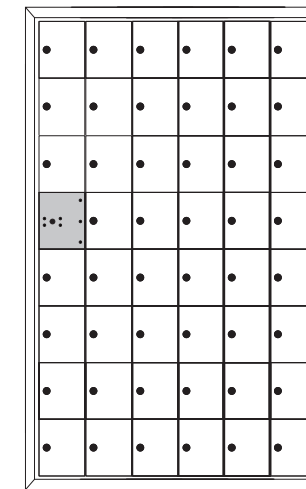

160086A

Model	160083A	160084A	160085A	160086A
# Mailboxes (Max)	23	31	39	47
Actual Width	13-3/4"	17-13/16"	21-7/8"	25-15/16"
Rough Opening Width	14"	18-1/16"	22-1/8"	26-3/16"

### NOTES:

All standard horizontal mailbox modules shown above are also available in rear-load.

All model numbers listed are for front-load modules; change the first four numbers from 1600 to 1700 for rear-load modules and increase the max number of mailboxes by one.



**9 DOORS HIGH** Actual: 49-9/16" H / Rough Opening: 49-13/16" H

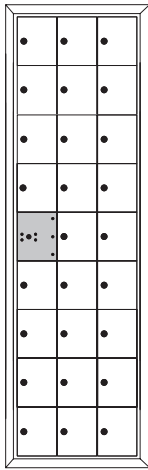

160093A

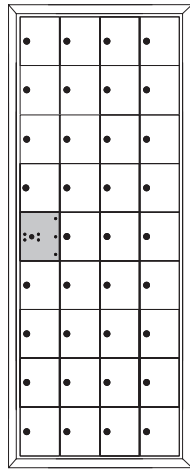

160094A

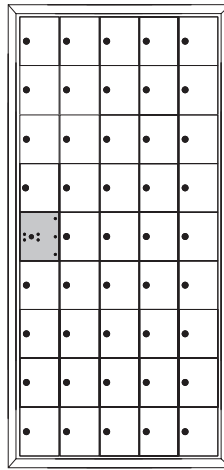

160095A

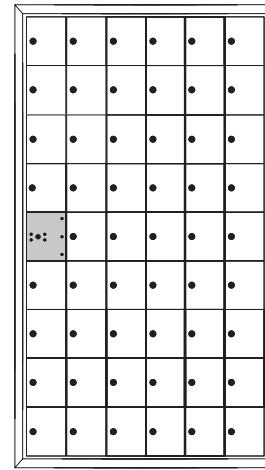

160096A

Model	160093A	160094A	160095A	160096A
# Mailboxes (Max)	26	35	44	53
Actual Width	13-3/4"	17-13/16"	21-7/8"	25-15/16"
Rough Opening Width	14"	18-1/16"	22-1/8"	26-3/16"

**11 DOORS HIGH** Actual: 60-3/8" H / Rough Opening: 60-5/8" H

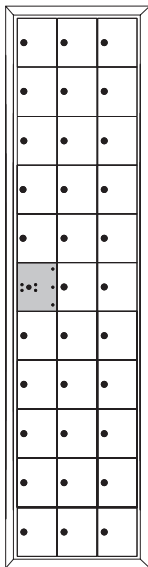

1600113A

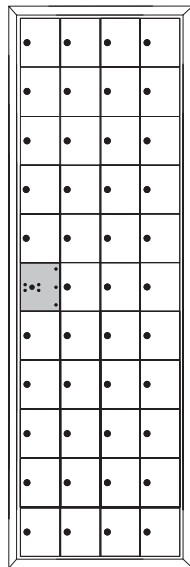

1600114A

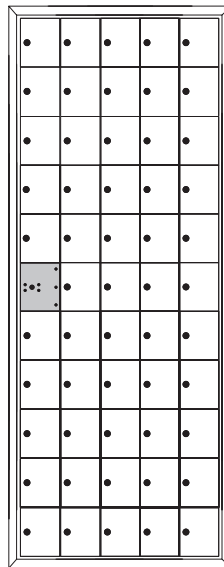

1600115A

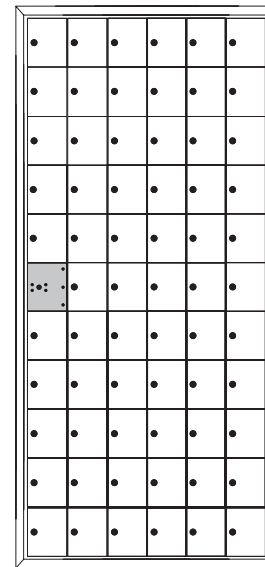

1600116A

Model	1600113A	1600114A	1600115A	1600116A
# Mailboxes (Max)	32	43	54	65
Actual Width	13-3/4"	17-13/16"	21-7/8"	25-15/16"
Rough Opening Width	14"	18-1/16"	22-1/8"	26-3/16"

**NOTES:**

All standard horizontal mailbox modules shown are also available in rear-load.

All model numbers listed are for front-load modules; change the first four numbers from 1600 to 1700 for rear-load modules and increase the max number of mailboxes by one.

# Horizontal Mailboxes

## 10 DOORS HIGH Actual: 55"H / Rough Opening: 54-1/4"H

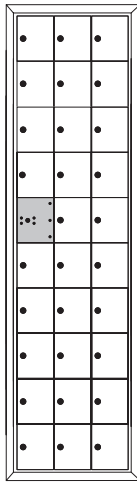

**1600103A**

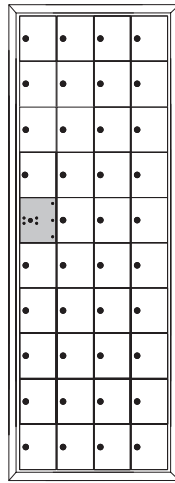

**1600104A**

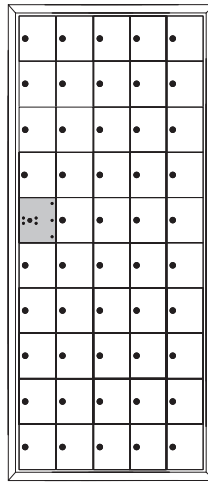

**1600105A**

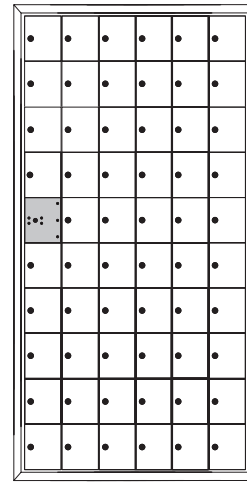

**1600106A**

Model	1600103A	1600104A	1600105A	1600106A
# Mailboxes (Max)	29	39	49	59
Actual Width	13-3/4"	17-13/16"	21-7/8"	25-15/16"
Rough Opening Width	14"	18-1/16"	22-1/8"	26-3/16"

## 12 DOORS HIGH Actual: 65-13/16"H / Rough Opening: 66-1/16"H

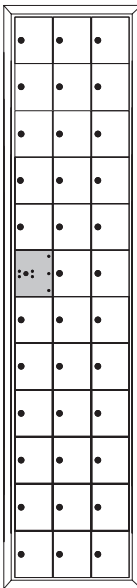

**1600123A**

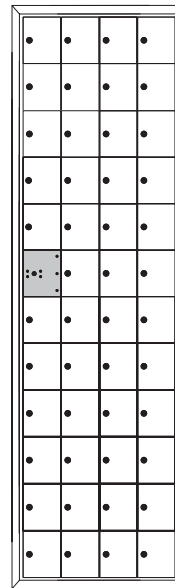

**1600124A**

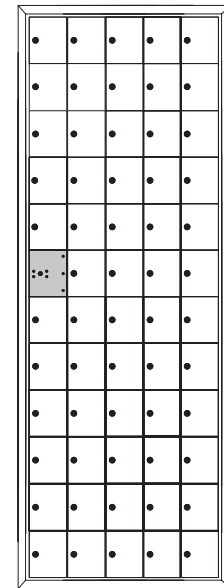

**1600125A**

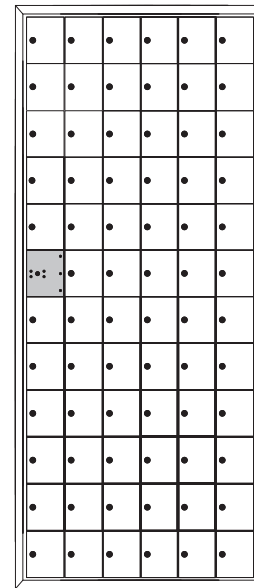

**1600126A**

Model	1600123A	1600124A	1600125A	1600126A
# Mailboxes (Max)	35	47	59	71
Actual Width	13-3/4"	17-13/16"	21-7/8"	25-15/16"
Rough Opening Width	14"	18-1/16"	22-1/8"	26-3/16"

**NOTES:**

All standard horizontal mailbox modules shown are also available in rear-load.

All model numbers listed are for front-load modules; change the first four numbers from 1600 to 1700 for rear-load modules and increase the max number of mailboxes by one.

# 1600/1700 Series - Custom

## for Private Delivery



Sometimes a standard sized compartment is simply not big enough to suit your residents' needs. That's why you can change mail compartment sizes or add as many collection and/or parcel lockers as your installation requires when you start with the custom all tenant compartment unit. These simple configurable options provide greater flexibility in door selection to ensure you can easily replace your current installation (see door size chart for options).

 [florencemailboxes.com/configurator](http://florencemailboxes.com/configurator)



**Note:** Horizontal mailbox installations should be protected from direct exposure to the weather; Florence is not responsible for damage caused by weather conditions as these products are rated for indoor use only.

### Optional Features

- Eight architectural powder coat color finishes
- Combination lock
- Hinged rear doors with private lock (for 1700)
- Configurable door sizes and layout options

### Lock Selections

Cam-lock is standard on all 1600/1700 horizontal mailboxes and comes with two keys (1,000 key changes). Combination lock option also available.



*For lock maintenance, only graphite type lubricants are recommended on product locks. For additional assistance with locks, contact your local locksmith.*

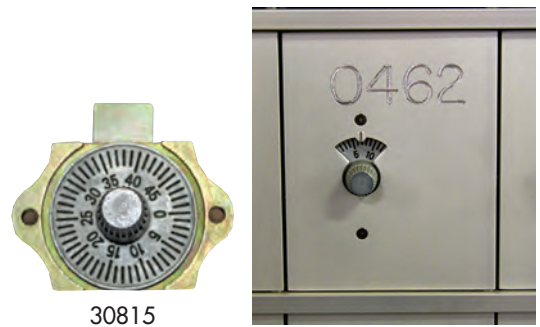

### Color Options

**Anodized Aluminum is standard for all horizontal mailboxes. Upgrade your installation to one of eight different architectural color options, all in a durable, powder coat finish.**

*Colors shown are representative of the actual powder coat finish but are limited by printing conditions and may vary slightly from finished product.*

<b>Antique Bronze (AB)</b> PMS 8622C	<b>Black (BK)</b> PMS Black 6C	<b>Dark Bronze (DB)</b> PMS Black 7C	<b>Gold Speck (GS)</b> PMS 7-5C
<b>Postal Grey (PG)</b> PMS 413C	<b>Sandstone (SD)</b> PMS 7501C	<b>Silver Speck (SS)</b> PMS 877C	<b>White (WH)</b> PMS White



## Configurable Modules



Go beyond the standard and create your own custom mailbox!

To quickly design your custom horizontal mailbox installation, Florence has developed an easy-to-use mailbox configurator which is unique to the industry. This do-it-yourself online tool provides the opportunity for you to place the doors not only where you want them, but with as many as you want (see door options in chart below). Our configurator tool will do the math for you, provide a drawing, and even allows you to submit your unique creation for quote!

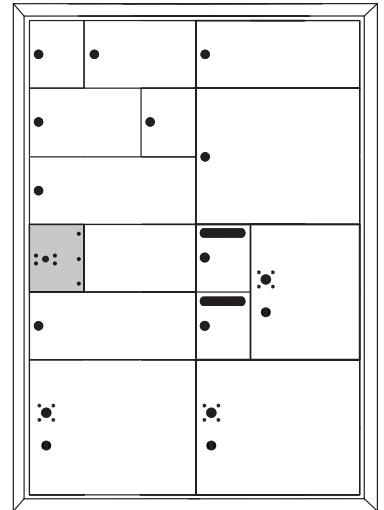

So go ahead and add multiple collection compartments - it's your design!

## Door Sizes

Configurable units available in cabinet sizes 3 - 6 Wide and 7 - 12 High.

**1600/1700**  
One-High, One-Wide  
(5" H x 4" W)

### Tenant Compartments



### Collection Compartments



NOTE: Collection compartments are available with or without an access lock.

### Parcel Locker Compartments

**1603/1703**  
One-High, Two-Wide  
(5" H x 8-1/16" W)



**1605/1705**  
One-High, Three-Wide  
(5" H x 12-1/8" W)



**1604/1704**  
Two-High, Two-Wide  
(10-3/8" H x 8-1/16" W)

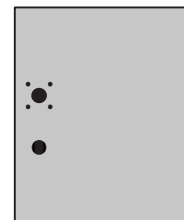
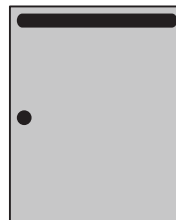
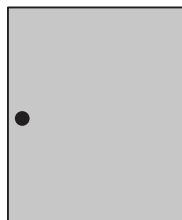

**1607/1707**  
Two-High, Three-Wide  
(10-3/8" H x 12-1/8" W)

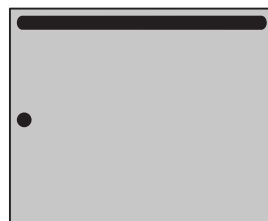
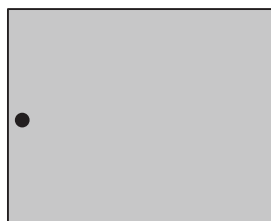

# 1250 Vertical Mailboxes

## for Postal Delivery



Vertical mailboxes can be used for Postal Delivery *only* when they replace older vertical mailboxes. Over the years, postal regulations have changed and these mailboxes are no longer approved for new construction. As these units are top-loading, they should be protected from the weather.

### Standard Features

- Top Load
- Recessed- or surface-mounted
- Prepared for USPS installed Master Lock
- Anodized aluminum finish
- 5-pin cylinder cam locks with two keys (1,000 key changes)
- Name and number ID card holders



### Door Size

The 1250 vertical series mailbox is pre-configured with one door size.

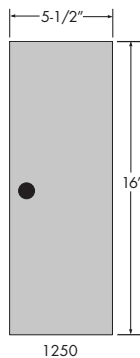

### Lock Option

The 1250 vertical series comes standard with a K30809 lock.



### Optional Features

- Private master lock
- Eight architectural powder coat finishes

### Color Options

Anodized Aluminum is standard for all vertical mailboxes. Upgrade your installation to one of eight different architectural color options, all in a durable, powder coat finish.

Colors shown are representative of the actual powder coat finish but are limited by printing conditions and may vary slightly from finished product.

<b>Antique Bronze (AB)</b> PMS 8622C	<b>Black (BK)</b> PMS Black 6C	<b>Dark Bronze (DB)</b> PMS Black 7C	<b>Gold Speck (GS)</b> PMS 7-5C
<b>Postal Grey (PG)</b> PMS 413C	<b>Sandstone (SD)</b> PMS 7501C	<b>Silver Speck (SS)</b> PMS 877C	<b>White (WH)</b> PMS White

# Vertical Mailboxes



## VERTICAL MAILBOX ALL CABINETS: 19-1/8" H 6-1/8" D

Single Row	Double Row	Layout Per Row	Wall Cut Width	Overall Width
3	6	3	17-1/2"	19"
4	8	4	23"	24-1/2"
5	10	5	28-5/8"	30-1/8"
6	12	6	34-1/8"	35-5/8"
7	14	7	39-5/8"	41-1/8"
8	16	4-4	47-1/2"	49"
9	18	5-4	53-1/8"	54-5/8"
10	20	5-5	58-3/4"	60-1/4"
11	22	6-5	64-1/4"	65-3/4"
12	24	6-6	69-3/4"	71-1/4"
13	26	7-6	75-1/4"	76-3/4"
14	28	7-7	80-3/4"	82-1/4"
15	30	5-5-5	88-7/8"	90-3/8"
16	32	5-6-5	94-3/8"	95-7/8"
17	34	6-6-5	99-7/8"	101-3/8"
18	36	6-6-6	105-3/8"	106-7/8"
19	38	6-6-7	110-7/8"	112-3/8"
20	40	7-7-6	116-3/8"	117-7/8"
21	42	7-7-7	121-7/8"	123-3/8"
22	44	6-6-6-4	129-7/8"	131-3/8"
23	46	6-6-6-5	135-1/2"	137"
24	48	6-6-6-6	141"	142-1/2"
25	50	7-6-6-6	146-1/2"	148"
26	52	7-7-7-5	152"	153-1/2"
27	54	7-7-7-6	157-1/2"	159"
28	56	7-7-7-7	163"	164-1/2"
29	58	6-6-6-6-5	171-1/8"	172-5/8"
30	60	6-6-6-6-6	176-5/8"	178-1/8"

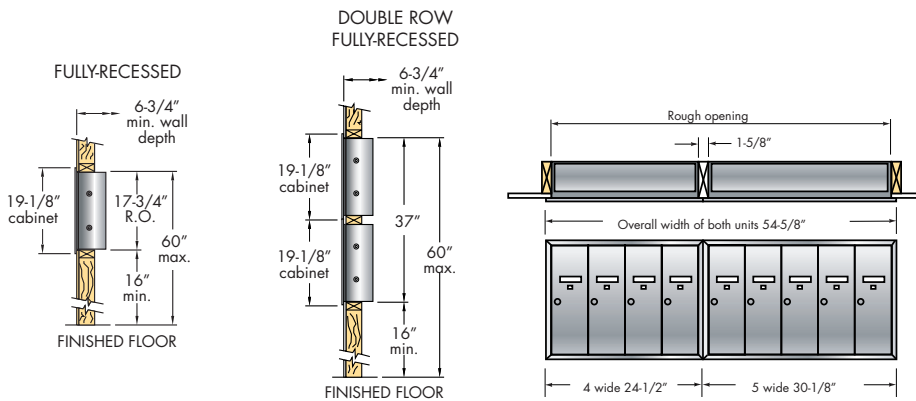

**Single Row**  
Wall Cut Depth = 6-3/4"  
Wall Cut Height = 17-3/4"  
Overall Height = 19-1/8"

**Double Row**  
Wall Cut Depth = 6-3/4"  
Wall Cut Height = 37"  
Overall Height = 38-1/4"

Note: Vertical mailbox installations should always be protected from direct exposure to the weather. Florence Corporation is not responsible for damage caused by weather conditions.

## Surface-Mount Collar

When your mailbox installation location has limited wall depth or walls that are covered in material which makes it difficult to cut a rough opening, the 1250 vertical series has a surface-mount collar option. This collar provides a sleek, finished look for the mailbox.



## VERTICAL MAILBOX MODEL NUMBERS

Number of Compartments	Surface Mount Model Number
3	12503SMSHA
4	12504SMSHA
5	12505SMSHA
6	12506SMSHA
7	12507SMSHA



## SURFACE MOUNTED

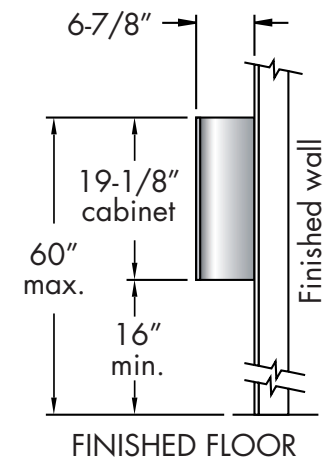



# Mailbox Accessories

## for Postal or Private Use

### Key Keepers

 [florencemailboxes.com/keykeepers](http://florencemailboxes.com/keykeepers)

Florence Key Keepers allow postal employees the ability to enter automatically locking entry doors to distribute mail in accordance with USPS regulations. The standard KK model is manufactured to accept a postal lock installed by local Postal Officials. Private master lock access also available.



Model KK



### Standard Features

- Recessed- or surface-mounted
- Prepared for USPS installed master lock
- Anodized aluminum or powder coat finish (see pg 51)
- Extruded aluminum construction
- Exterior dims: 6-3/4" H x 6-1/4" W x 2-3/8" D
- Interior dims: 4-5/8" H x 4-1/16" W x 2" D
- Rough opening: 5-1/8" H x 4-3/8" W x 2-1/4" D

### Optional Features

- Private master lock
- Retractable reel

### Directories

These surface mounted directories can be used independently or installed next to any mailbox installation to neatly and alphabetically list the names of all your residents. A clear plastic window, metal back plate and blank ruled name cards are all included with each directory.

### Standard Features

- Anodized aluminum or powder coat finish (see pg 51)
- Extruded aluminum construction
- 40 or 80 name capacity
- D400-1: 19" H x 8-3/4" W
- D400-2: 19" H x 15-1/8" W

 [florencemailboxes.com/directories](http://florencemailboxes.com/directories)



D400-1A



D400-2A

## 120 Series Letter Box

 [florencemailboxes.com/letterbox](http://florencemailboxes.com/letterbox)

Whether they are used alone or in conjunction with other Florence mailboxes, these indoor letter boxes secure mail awaiting pick up by the USPS and are a natural extension of your mailbox system.



120SPSMS

### Standard Features

- Front load, Recessed-mounted
- Prepared for USPS installed master lock
- Anodized aluminum or powder coat finish (see options below)
- Engraved "LETTERS" or designated custom engraving
- Frame Size: 19-1/8"H x 15-1/6" W
- Rough Opening Size: 17-5/8" H x 13-5/8" W x 6 -3/4" D
- Letter slot size: 3/4"H x 10"W

### Optional Features

- Private master lock available
- Surface mount collar

## Letter Drop

 [florencemailboxes.com/letterdrop](http://florencemailboxes.com/letterdrop)

The LD12 Letter Drop allows for deposit of mail through a spring-loaded flap mounted into a wall.

### Standard Features

- Spring-hinged front flap
- Anodized aluminum or powder coat finish (see options below)
- Engraved "U.S. MAIL" or designated custom engraving



### Optional Features

- 8" or 12" angled wall liner
- Back plate
- Frame size: 6-3/8"H x 14-1/16"W x 3/4"D
- Rough opening size: 5" H x 12-5/8" W
- Door size: 4" H x 11-3/4" W

## 120SMLDL

Combining the 120 Letter Box with the LD12 (with liner) Letter Drop, creates a unique collection box solution. The 120SMLDL allows for deposit and secure collection of mail, or other documents in private applications.



120SMLDLA

## Color Options

Select either Anodized Aluminum or one of eight different architectural powder coat finishes as noted for all mailbox accessories.

Colors shown are representative of the actual powder coat finish but are limited by printing conditions and may vary slightly from finished product.

<b>Antique Bronze (AB)</b> PMS 8622C	<b>Black (BK)</b> PMS Black 6C	<b>Dark Bronze (DB)</b> PMS Black 7C	<b>Gold Speck (GS)</b> PMS 7-5C
<b>Postal Grey (PG)</b> PMS 413C	<b>Sandstone (SD)</b> PMS 7501C	<b>Silver Speck (SS)</b> PMS 877C	<b>White (WH)</b> PMS White

# Collection Boxes

## for Letters or Packages



## versatile™ Collection Centers

Use this secure product for all your individual collection needs; whether that includes x-rays, DVD/Blu Rays, books, key drop, etc. for private collection, or as a wall-mounted version for postal collection. The patent pending hopper mechanism and collection box lock ensure contents remain safe and secure. Designed to be suitable for indoor or outdoor use, it is available in nine wall- or pedestal-mount heights.

## Standard Features

- Collection box units can be installed recess- or surface-mounted on a wall, with a pedestal, or encased within a vario™ 4C express or depot
- Units designed to meet ADA/DOJ, ICC/ANSI, and IBC 2006 compliance for maximum 48" door access when installed 14-1/8" above the finished floor
- Unique designs seals off access to the main collection compartment when open to prevent mail fishing.
- Once unit is full, hopper door will not open to accept more items

 [florencemailboxes.com/collection](http://florencemailboxes.com/collection)

### Did you know?

The Postal Regulation that pertains to collection centers is USPS Publication 16 and states local Postal Authorities must approve all units prior to installation.

## Color Options

Customize your versatile™ Collection Boxes with eight different architectural powder coat finishes.

Colors shown are representative of the actual powder coat finish but are limited by printing conditions and may vary slightly from finished product.





## Hopper Selections

Florence is pleased to be the only manufacturer to have achieved USPS Approval status for its versatile™ 4C collection box. Designed to coordinate with the versatile™ 4C mailbox suites (see pages 18 - 29 for mailbox product details), select as many modules as needed for your project.



4C16S-HOP 4C15S-HOP 4C14S-HOP 4C13S-HOP 4C12S-HOP 4C11S-HOP 4C10S-HOP 4C09S-HOP 4C08S-HOP



4C16S-HOP 4C15S-HOP 4C14S-HOP 4C13S-HOP 4C12S-HOP 4C11S-HOP 4C10S-HOP 4C09S-HOP 4C08S-HOP

**Note:** Free-standing collection boxes for postal delivery must be pre-approved by postal officials.



4C10S-HOP

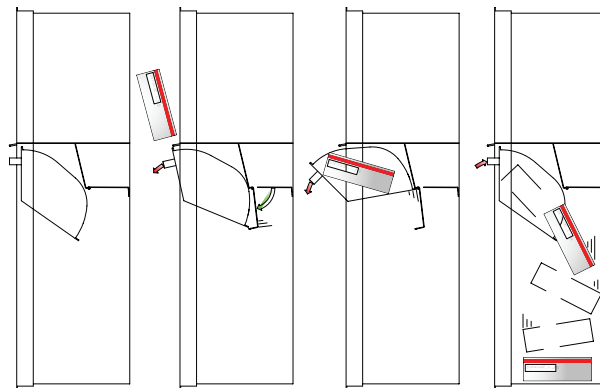

When open, hopper door extends 5-7/16" from unit and seals off access to the main collection compartment. Once unit is full, hopper door will not open to accept more items.

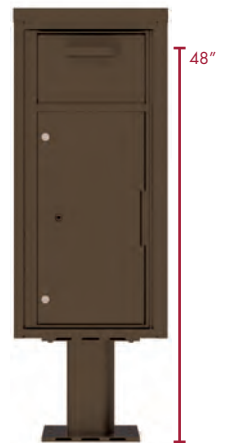

4CADS-HOP-P

# Collection Bins

## for Waste / Recycling



## versatile™ Trash / Recycling Bins

Since these bins were designed as part of the versatile™ 4C mailbox line, they are the perfect complement to your centralized mail center. Keep the area tidy by providing receptacles for the disposal of junk mail, or create a standalone recycling center for the convenience of your residents.

### Standard Features

- Constructed of heavy gauge aluminum and stainless steel components
- Included interior collection receptacle(s) constructed of all recycled materials
- Master door includes 5-pin cam lock with three keys
- Door flap in brushed stainless steel with pre-printed decals: WASTE, TRASH, PLASTIC, GLASS or PAPER
- Recessed-mount

 [florencemailboxes.com/collection](http://florencemailboxes.com/collection)

### Standard Lock

The versatile™ 4C bins come standard with a 86009 lock.



86009

### Optional Features

- Custom door flap decals with up to 12 characters
- Combination lock or keyless latch options
- Powder coat finish door flap in coordinating color
- Eight powder coat color finishes
- Four mounting options

### Color Options

Customize your versatile™ Collection Bin with eight different architectural powder coat finishes.



Colors shown are representative of the actual powder coat finish but are limited by printing conditions and may vary slightly from finished product.

## Bin Selections

Florence is pleased to be the provider of the versatile™ 4C trash/recycling bins. Designed to coordinate with the versatile™ 4C mailbox suites (see pages 18 - 29 for mailbox product details), select as many modules as needed for your project.

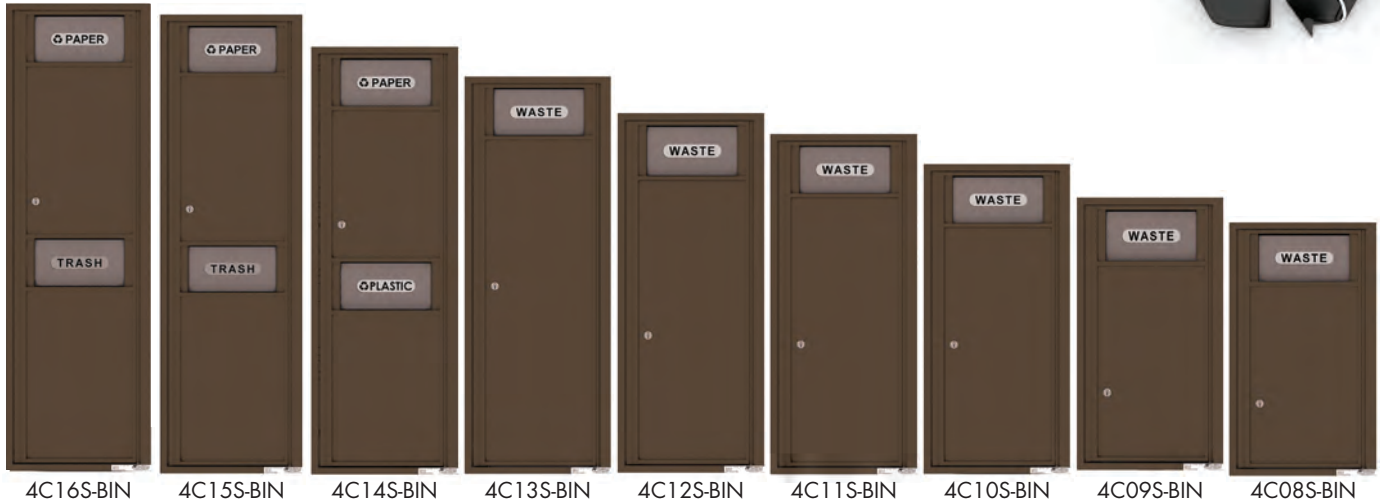

## Door Flap Decal Options

Choose from five standard decal options or create your own custom option with up to 12 characters.

**TRASH**

**WASTE**



**GLASS**



**PAPER**



**PLASTIC**

## Mounting Options

Three different mounting options provide greater flexibility in creating your recycling center or matching an existing mailbox installation:

- Recessed-mount (shown above)
- Surface-mount collar (see page 33)
- Pedestal-mount (see pages 34 - 35)

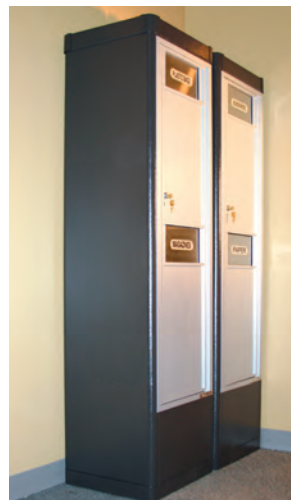



# Mini Storage Lockers

## for Small Item Security

**Mini**  
STORAGE LOCKER



These mini lockers are convenient for any facility where cell phones are not allowed, or when temporary storage of small valuables such as keys, wallet, jewelry/watches, or other electronic devices are needed.

### Standard Features

- Front-load or fixed gate
- Recessed- or surface-mounted (7-1/2" depth)
- Private master lock or no master lock option
- Anodized aluminum finish
- 5-pin cylinder cam lock with two keys
- Clear plastic number slots or engraved numbers
- Snap on trim (available upon request)

### Optional Features

- Eight powder coat color finishes
- Combination lock
- Configurable door sizes and layout options

### Custom Door Size Options

Need more than the standard configurations shown on page 57, our easy-to-use online configurator allows you to complete your project from the full range of size options.

 [florencemailboxes.com/configurator](http://florencemailboxes.com/configurator)

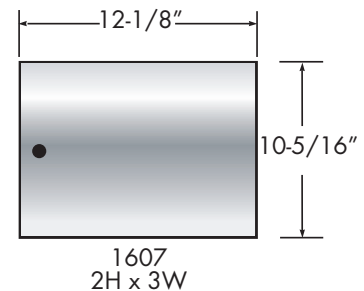
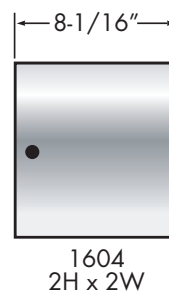
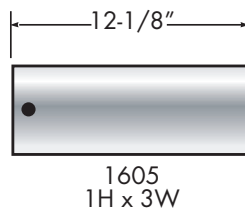
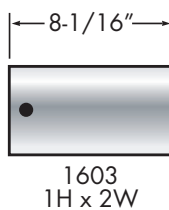
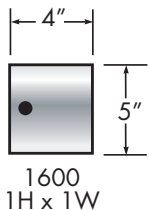

### Color Options

Anodized Aluminum is standard for all mini storage lockers. Upgrade your installation to one of eight different architectural color options, all in a durable, powder coat finish.

Colors shown are representative of the actual powder coat finish but are limited by printing conditions and may vary slightly from finished product.

**Antique Bronze (AB)**  
PMS 8622C

**Black (BK)**  
PMS Black 6C

**Dark Bronze (DB)**  
PMS Black 7C

**Gold Speck (GS)**  
PMS 7-5C

**Postal Grey (PG)**  
PMS 413C

**Sandstone (SD)**  
PMS 7501C

**Silver Speck (SS)**  
PMS 877C

**White (WH)**  
PMS White

# Mini Storage Lockers

## 3 DOORS HIGH Actual: 17-1/8"H / Rough Opening: 17-3/8"H

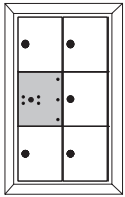

**MINI32AF**

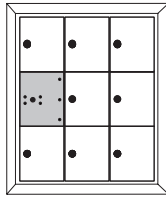

**MINI33AF**

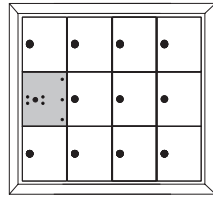

**MINI34AF**

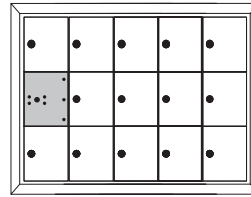

**MINI35AF**

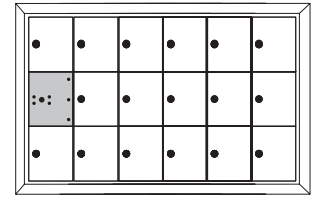

**MINI36AF**

Model	MINI32AF	MINI33AF	MINI34AF	MINI35AF	MINI36AF
# Lockers (Max)	5	8	11	14	17
Actual Width	9-5/8"	13-3/4"	17-13/16"	21-7/8"	25-15/16"
Rough Opening Width	9-7/8"	14"	18-1/16"	22-1/8"	26-3/16"

## 4 DOORS HIGH Actual: 22-9/16"H / Rough Opening: 22-13/16"H

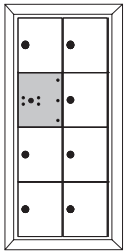

**MINI42AF**

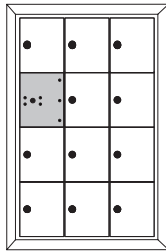

**MINI43AF**

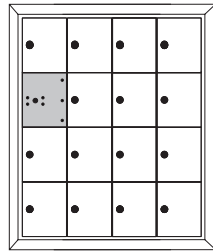

**MINI44AF**

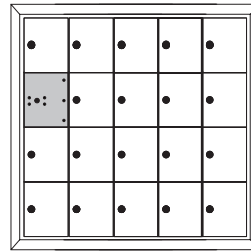

**MINI45AF**

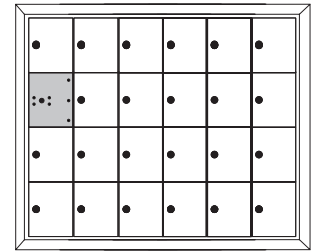

**MINI46AF**

Model	MINI42AF	MINI43AF	MINI44AF	MINI45AF	MINI46AF
# Lockers (Max)	7	11	15	19	23
Actual Width	9-5/8"	13-3/4"	17-13/16"	21-7/8"	25-15/16"
Rough Opening Width	9-7/8"	14"	18-1/16"	22-1/8"	26-3/16"

## 5 DOORS HIGH Actual: 27-15/16"H / Rough Opening: 28-3/16"H

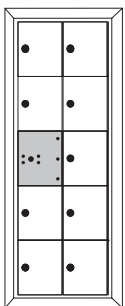

**MINI52AF**

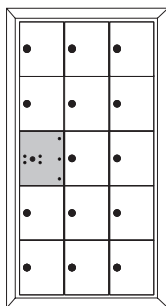

**MINI53AF**

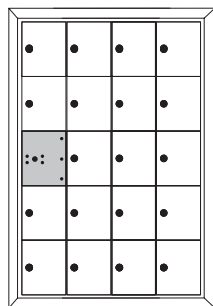

**MINI54AF**

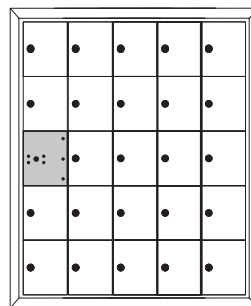

**MINI55AF**

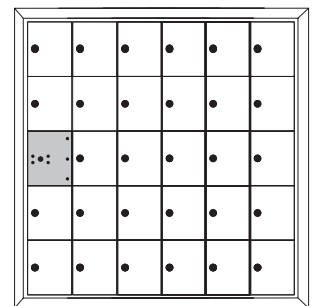

**MINI56AF**

Model	MINI52AF	MINI53AF	MINI54AF	MINI55AF	MINI56AF
# Lockers (Max)	9	14	19	23	29
Actual Width	9-5/8"	13-3/4"	17-13/16"	21-7/8"	25-15/16"
Rough Opening Width	9-7/8"	14"	18-1/16"	22-1/8"	26-3/16"

**NOTES:**

All standard modules are fully configurable, visit [florencemailboxes.com/configure](http://florencemailboxes.com/configure) to quickly and easily create your custom solution. Additional compartment sizes are shown on page 56. For all fixed gate modules, the master door will be replaced with an additional locker compartment and therefore the max compartment number will increase by one. All model numbers listed are for standard modules; add -SP for custom modules at the end of the number.



# Centralized Mail Delivery

## *Equipment Options*

Centralized mail delivery provides delivery and collection services to a number of residences from a centrally located installation – whether in a single-family subdivision or multi-family structure. Business customers also receive delivery services from a convenient central location.

The U.S. Postal Service now specifies centralized mail delivery in nearly all new construction because it is the most efficient method of providing the best service, which helps keep the cost of mail service affordable.

Centralized mail delivery equipment can be in the form of any “clustered” style of mailboxes including free-standing, pedestal mounted Cluster Box Units (CBU), or other Standard 4C (STD-4C) compliant mailboxes mounted in or on a wall.

Manufacturers must produce a mailbox which meets or exceeds all US Postal Service (USPS) Specifications and then submit a prototype to the USPS for rigorous testing and approval. Once accepted, the final product will receive the appropriate designation and be approved for





use. All STD-4C compliant mailboxes must meet the USPS design and installation regulations to receive a “USPS Approved” designation; while all CBUs must *also* be officially licensed by the USPS.

Not only is approved centralized mail delivery equipment now specified by the USPS for nearly all new construction projects, but newer types of equipment may also be required for any major renovation to older existing mailbox installations. For instance, if your project will disturb the rough opening of the wall your mailboxes are currently mounted into, new centralized mail delivery equipment such as the STD-4C may be required.

Besides wall-mounting, it is also vital that subdivision regulations and other community planning guidelines address the need to review and include common space planning for centralized mail delivery equipment – an all too often last minute consideration. This important public service should be addressed early in the planning process to provide developers with comprehensive resources which will help avoid headaches later and ensure mail delivery is not delayed. Effective pre-planning not only allows

for the creation of a true community gathering area, but ensures that residents will not have to stand in the street, or have limited access to safely retrieve their mail and packages.

It is important to check with local postal officials prior to planning *any* mailbox installation to ensure local requirements and proper placement is included in the overall design plan.

To find a complete list of USPS Approved manufacturers, a local Post Office®, and/or the proper postal official nearest you, visit [USPS.com](https://www.usps.com), or call 800-ASK-USPS (800-275-8777).



# Design and Service Support

*Online Resources, Design Assistance & More!*

## Superior Architectural Resources



 [florencemailboxes.com/toolkit](https://florencemailboxes.com/toolkit)

Florence has a long standing tradition of providing architects with the tools they need to complete the job right the first time; conveniently accessed from the Online Architect Toolkit. Whether you need continuing education credits, assistance in navigating current postal regulations, or product specific CAD drawings, BIM objects, or written specifications; Florence is here when you need us.

If your firm is utilizing Revit, our BIM objects can easily be pulled into your projects through the Library without leaving the program; or, they can quickly be downloaded directly from the Florence website. A short 'how-to' video is also available to guide you through customizing your Florence BIM mailbox objects so they fit your exact project needs. Of course written specifications are also available from the website in both .doc and .rtf format.

Florence Manufacturing has been included in master specs for decades and is pleased to be specified in over 80% of all projects requiring Section 10 55 00 Postal Specialties. Other names we may be listed under include: Auth, Auth-Florence, Auth-Electric, American Device, Cutler, Florence, Florence Corporation, and Florence Manufacturing.

## Exceptional Customer Service

 [florencemailboxes.com/customerservice](https://florencemailboxes.com/customerservice)

Florence Corporation is proud to provide a complete support team to serve your needs. Not only are our friendly customer service representatives ready to assist you in locating an Authorized Dealer or answering your product questions, but a full team of engineering, design, manufacturing, quality, marketing, and sales professionals are available to answer your questions too.

This dedicated team can help ensure your project includes the correct product to solve your centralized mail delivery needs, help guide you through current postal regulations, and assist you in determining the correct product solution for your existing mailbox installation that may need replacing or refurbishing.

As your partner in mailboxes and storage solutions since 1934, Florence understands the importance of exceptional service and that is why we connect you with the right partner who will find you the right product solution.





## Authorized Florence Dealer Network



installations, as well as help you navigate local postal requirements to ensure mail delivery is not disrupted for your tenants. And if it is a new mailbox installation, this professional team will work with your local resources to ensure proper placement the first time.

 [florencemailboxes.com/dealers](https://florencemailboxes.com/dealers)

To ensure your project goes smoothly from conception to construction, our nationwide network of Authorized Florence Dealers is ready to assist you every step of the way. These product specialists can provide quote information on large jobs, help you select the right products for your project, provide technical assistance, and even in some cases install everything for you.

This dedicated team of knowledgeable individuals can also assist with replacement and refurbishment of your current mailbox



## REQUEST A QUOTE

An Authorized Florence Dealer will quickly respond with:

- Comprehensive Project Estimates
- Recommended Florence Products
- Volume Pricing Options



By purchasing products directly through distributors rather than the factory, you are guaranteed local, friendly service to help guide you throughout the entire process; providing you with a trusted resource even *after* the sale.

Or, sometimes your project just needs someone to be on-site; so whether your project is just down the street, around the corner, or across the country, visit our online Dealer Locator to find the assistance you need. . .where you need it.

 [florencemailboxes.com/dealerlocator](https://florencemailboxes.com/dealerlocator)





# Replacement Parts

## Important Product Info

 [florencemailboxes.com/parts](http://florencemailboxes.com/parts)

### Product and Manufacturer Serial Tags

When attempting to determine what replacement parts you may need, begin by simply reviewing the labels attached to the product. Typically the manufacturer contact information can be found on labels either on the front lower right, or back of the product. If no label exists, just take a photograph of the product and email it to us, we'll help you identify exactly what you are looking for!

### U.S. MAIL

U.S. PATENT NO. 7,748,606  
OTHER PATENTS ARE PENDING

#### FLORENCE CORPORATION

5935 CORPORATE DRIVE  
MANHATTAN, KANSAS 66503  
[www.florencemailboxes.com](http://www.florencemailboxes.com)  
800.275.1747

USPS CONTRACT NO:  
USPS LICENSE NO:  
OEM SERIAL NO:  
DATE MANUFACTURED:

1CDSEQ-11-B-1004  
1CDSEQ-08-B-0012  
SN-TEST03  
DD-Mmm-YYYY

**FLORENCE**  
CORPORATION

5935 Corporate Drive  
Manhattan, KS 66503  
800-275-1747  
[florencemailboxes.com](http://florencemailboxes.com)



### Product Door Type

Another way to identify the mailbox type for replacement purposes is by the shape of the compartments.

The tall and skinny doors are from the vertical mailbox line (pg 48).



A square door is most likely in the horizontal mailbox lines (pg 38).



The wider rectangular doors are in CBU (pg 8) or 4C (pg 14).



### Replacement Parts



Looking to repair your older mailboxes? Chances are Florence can bring new life to the unit with replacement parts such as doors, locks, keys, and various hardware. When the situation calls for basic repairs rather than replacing the entire unit, simply contact an Authorized Florence Dealer or visit our website for assistance.

(To find an Authorized Dealer near you, visit our online Dealer Locator.)

### Replacement Keys



The loss of a mailbox key can be a frustrating experience. For emergency key situations, contact a local locksmith or hardware store. Otherwise, the entire lock mechanism for the mailbox compartment will need to be replaced. Work with your local postal carrier to gain access to the appropriate compartment as needed.

(Make sure to have manufacturer and number from the key handy for reference.)

## Important Product Info

### Made in the USA

 [florencemailboxes.com/made-in-the-usa](http://florencemailboxes.com/made-in-the-usa)

Located in the American Heartland, Florence Corporation has proudly made centralized mail delivery and storage equipment since 1934. Our approach to manufacturing and quality control allows us to effectively and efficiently produce and ship product from our Manhattan, KS facility. Our long standing American tradition and operation continues to be ISO certified for both our manufacturing and management processes as well as our environmental practices.



### Materials

All product descriptions and specifications contained herein were in effect at the time the catalog received final approval for printing. Note that not all powder coat color finishes are available on all Florence product lines; see individual product listings for details. Pantone color numbers shown in parentheses with finishes are for reference purposes only. Printed colors shown may vary slightly due to printing process. As Florence Corporation continually strives for efficiencies to pass along to our customers, we reserve the right to change specifications and/or designs without notice and without liability. Where appropriate, replacement items will be maintained during potential transition.

### Product Warranty

 [florencemailboxes.com/warranty](http://florencemailboxes.com/warranty)

Florence Corporation provides a five-year warranty on its products from the date of shipment when purchased from an Authorized Florence Dealer. Full details on the warranty, as well as how to find a local product expert nearest you, can be found by visiting our website or calling us today!



### Return Policy

All product shipments are adequately packaged, but should be thoroughly inspected upon receipt and *prior to acceptance*, for potential damage in transit. Returned goods will not be accepted without an RGA (returned goods authorization) number, which must be obtained from the Authorized Florence Dealer with whom you completed the transaction. In the event a product is authorized for a return, a minimum 30% restock will apply for standard stock products. Outbound freight and return freight is not credited as part of the return. Custom orders and orders with options cannot be cancelled and will not be accepted for return, exchange, or refund.

### Care and Cleaning

 [florencemailboxes.com/cleaning](http://florencemailboxes.com/cleaning)



The surface of all Florence clear aluminum or powder coated products may be cleaned of dirt or grime with a soft cloth dampened with any mild detergent or properly diluted biodegradable, water-based cleaner, such as "Simple Green™".

Wipe from top to bottom to avoid run-down. Avoid use of abrasives, which might damage the product surface. Rinse with plain water and dry. Avoid cleaning during extreme temperature conditions. Matching touch-up paint products may be available from an Authorized Florence Dealer for products which utilize powder coating. Full details can be found by visiting [www.florencemailboxes.com/cleaning](http://www.florencemailboxes.com/cleaning).

### Social Media - follow us!

Follow and/or like us on the popular social media platforms so together we can further the discussion on centralized mail delivery, its products, and other topics of interest in the industry. Be sure to also check out our blog where we regularly share pertinent topics of interest as you design and install your mailbox system; and subscribe to our YouTube channel where you can find product feature and 'how-to' videos.



### Copyright

Florence Corporation has made every effort possible to ensure the accuracy of all information contained within this publication. We reserve the right to correct inadvertent or typographical errors, inaccuracies or omissions - should they happen to occur - and to change or update information at any time without prior notice. All publication elements, including but not limited to, design, graphics, text, trademarks, art, and photographs, as well as the selection and arrangement thereof, are Copyright © 2017 Florence Corporation, All Rights Reserved. This catalog is intended for distribution by Florence Corporation and its Authorized Dealers for the sole purpose of purchasing products contained herein. Any other use of this publication, including modification or re-publication of any portion of the publication, without the prior written consent of Florence Corporation, is strictly prohibited. Printed in the USA on recycled paper.

# FLORENCE CORPORATION

Call us Today Toll-free  
800.275.1747

Visit Us Online for More Info  
FlorenceMailboxes.com



## Empowering Your Commercial and Residential Centralized Mailbox Designs for Over 80 Years!

Florence Corporation. Established. Dependable. Strong.

Like all great stories, ours started in a garage. Elbow grease, a sweaty brow. It's that kind of story. More than 80 years later, we're still hard at it; continually perfecting our craft, allowing you to perfect yours. You may take our products for granted. We take that as a compliment. Our products don't require attention or fuss. They're built smart, designed to work, and engineered to last.

We empower our customers with the products, the support, and the tools to design faster. Build smarter. Manage better. We understand that in a world of global commerce, demands of efficiency and last minute deadlines, you need a partner that can keep pace. You've met your match with Florence. Established. Dependable. Strong.

It's not just what we make...it's what makes us.